

- EXTRUDED ALUMINUM CONSTRUCTION
- ADJUSTABLE BARS ON 1 INCH CENTERS
- SCREW HOLE LOCATIONS STANDARD UNLESS OTHERWISE SPECIFIED
- FOR SCREW HOLE LOCATIONS SEE SD-9140
- MINIMUM SIZE: 6 X 4
- MAXIMUM SIZE: 72 X 36 OR 36 X 96 ONE PIECE CONSTRUCTION
- AVAILABLE IN 1 INCH INCREMENTS
- 1-WAY, 2-WAY AND 3-WAY DEFLECTIONS AVAILABLE
- FINISH: WHITE (W) ENAMEL OR SATIN ANODIZED (SA)

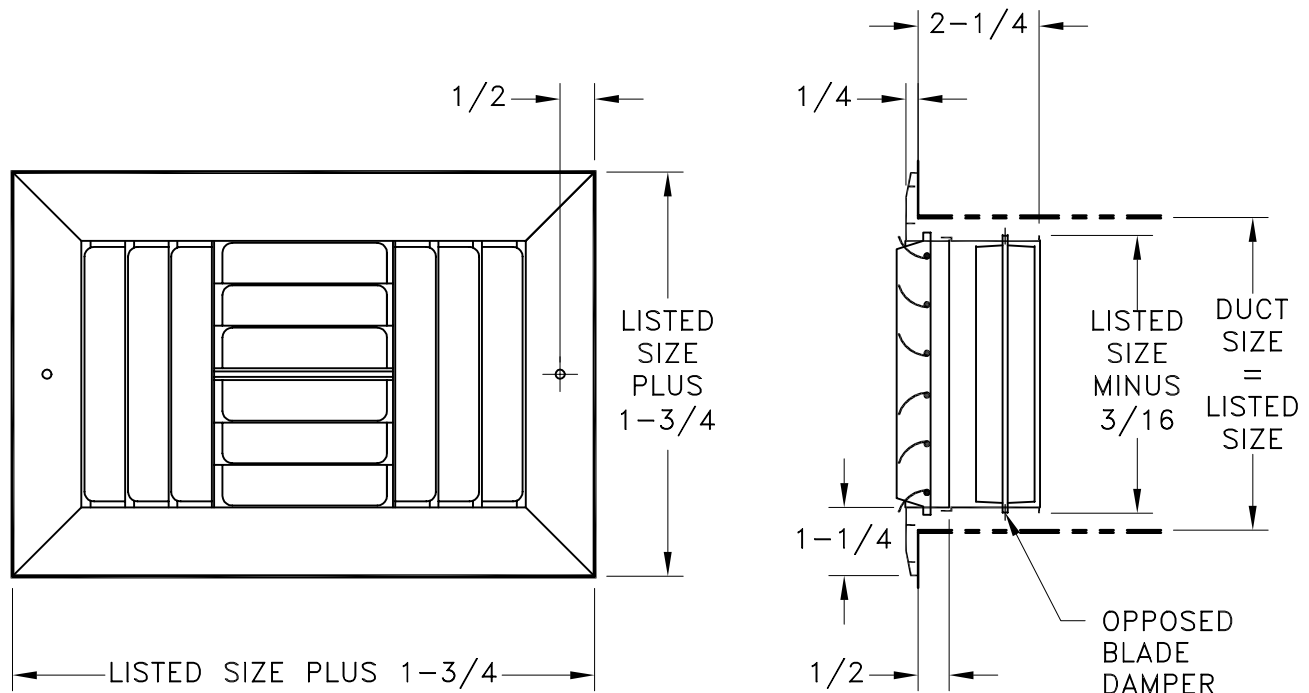

CD4 REGISTER

JOB NAME: _____	SUBMITTED BY: _____	DATE: 4/10/01	SD-9102
LOCATION: _____		CD SERIES	
ARCHITECT: _____		Extruded Aluminum	
ENGINEER: _____		Adjustable Curved Blade	
CONTRACTOR: _____		Registers With Opposed Blade Dampers	