

- ALL STEEL CONSTRUCTION
- INTEGRAL MULTI-SHUTTER DAMPER
- 1/2 INCH SPACED FINS SET AT 40 DEGREES
- MINIMUM SIZE = 6 X 4
- MAXIMUM SIZE = 24 X 8
- 2-WAY DEFLECTION
- FOR HEATING OR COOLING
- FINISH: WHITE (W) ENAMEL

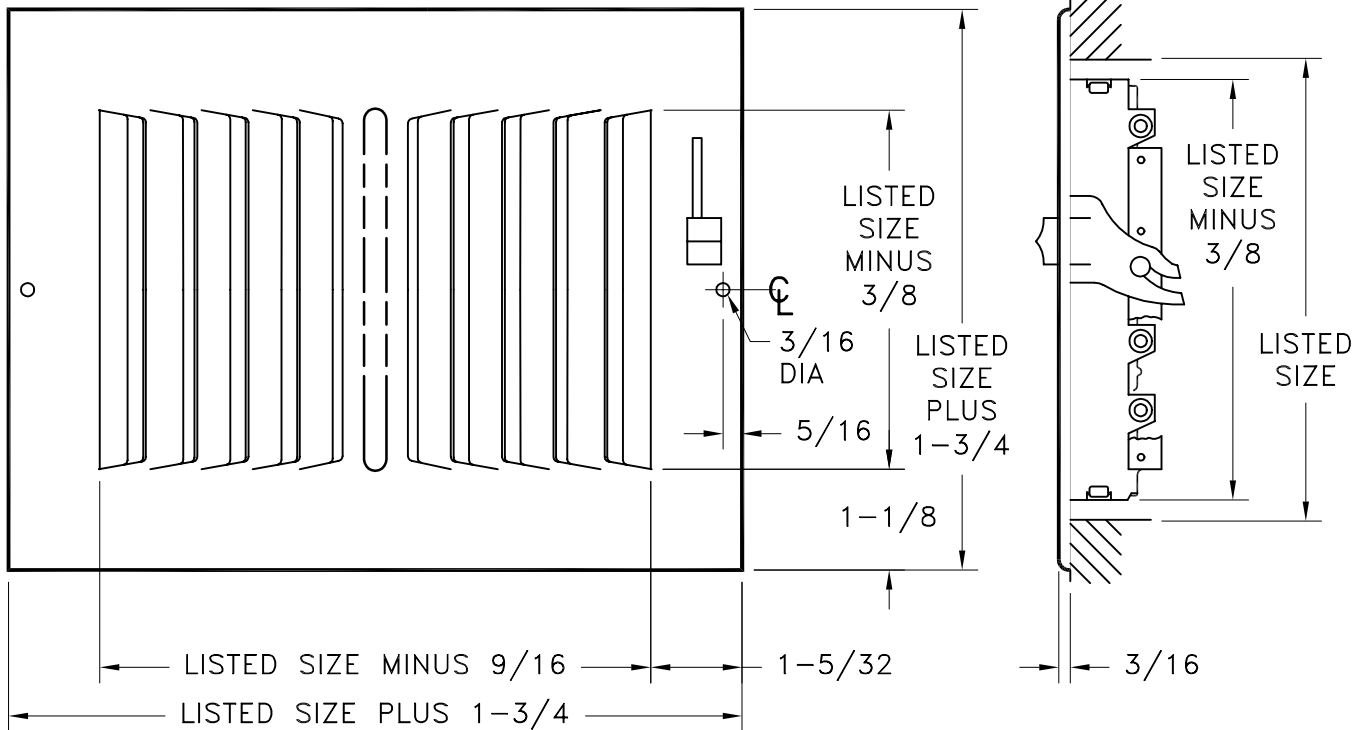

JOB NAME: _____	SUBMITTED BY: _____	DATE: 3/1/01	SD-2436
LOCATION: _____		682	
ARCHITECT: _____		Steel 2-Way	
ENGINEER: _____		Ceiling Or Sidewall Register	
CONTRACTOR: _____			