

- ALUMINUM FACE, ALUMINIZED AND GALVANIZED STEEL DAMPER
- ADJUSTABLE CURVED BLADES
- MULTI-SHUTTER DAMPER
- MINIMUM SIZE = 6 X 6
- MAXIMUM SIZE = 14 X 8
- FINISH: WHITE (W) ENAMEL OR SATIN ANODIZED (SA)

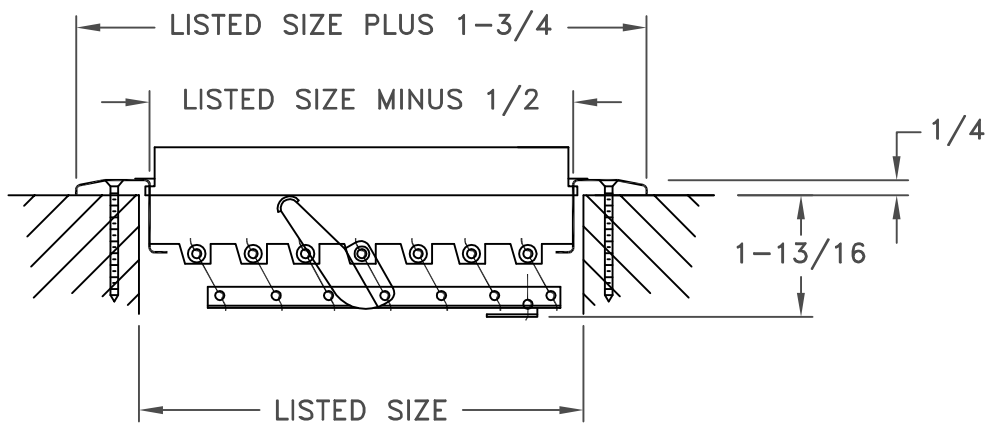
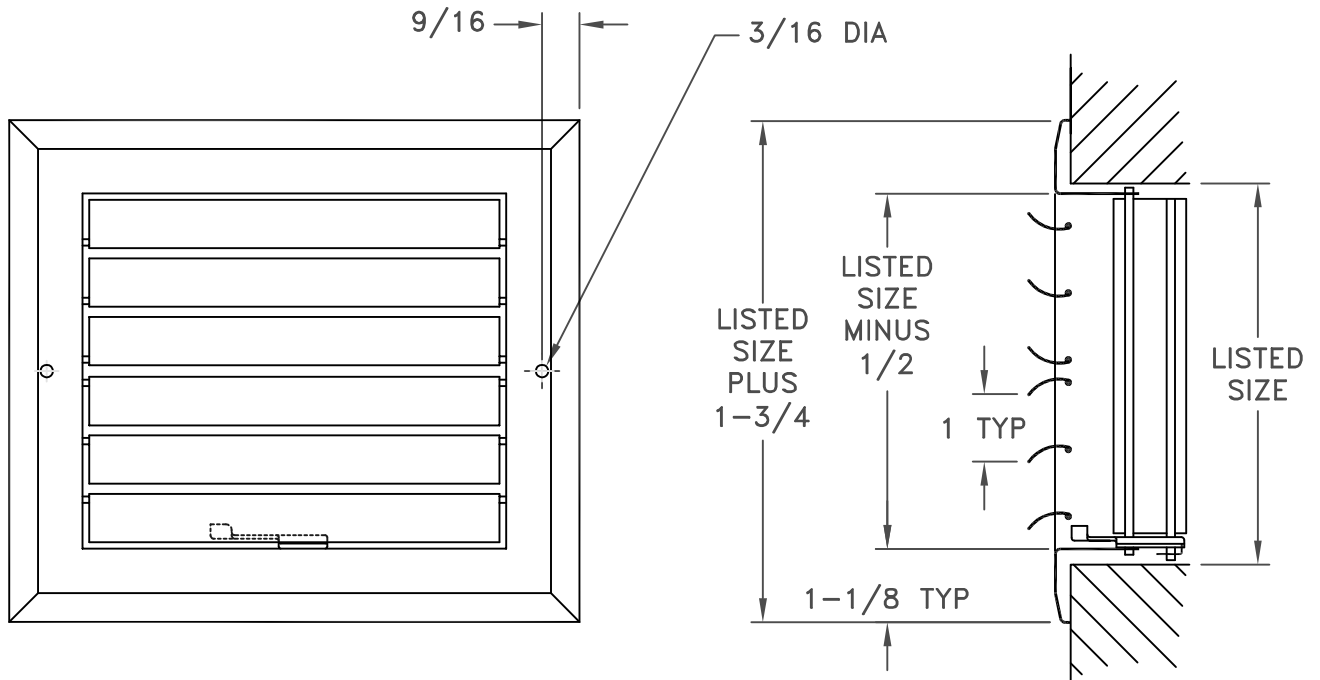

JOB NAME: _____	SUBMITTED BY: _____	DATE: 08/15/2013	SD-2502
LOCATION: _____		A612MS	
ARCHITECT: _____		Aluminum	
ENGINEER: _____		Curved Blade Register	
CONTRACTOR: _____		2-Way Air Pattern	