

- GALVANIZED STEEL CONSTRUCTION
- GANG OPERATED RADIAL BLADES
- ADJUSTMENTS MADE EASILY FROM FACE WITH A SCREWDRIVER
- INCLUDES INTEGRAL SPRING CLIPS FOR INSTALLATION ONTO DUCT COLLAR
- SIZES: 6", 8", 10", 12" AND 14" DIAMETERS
- FINISH: MILL

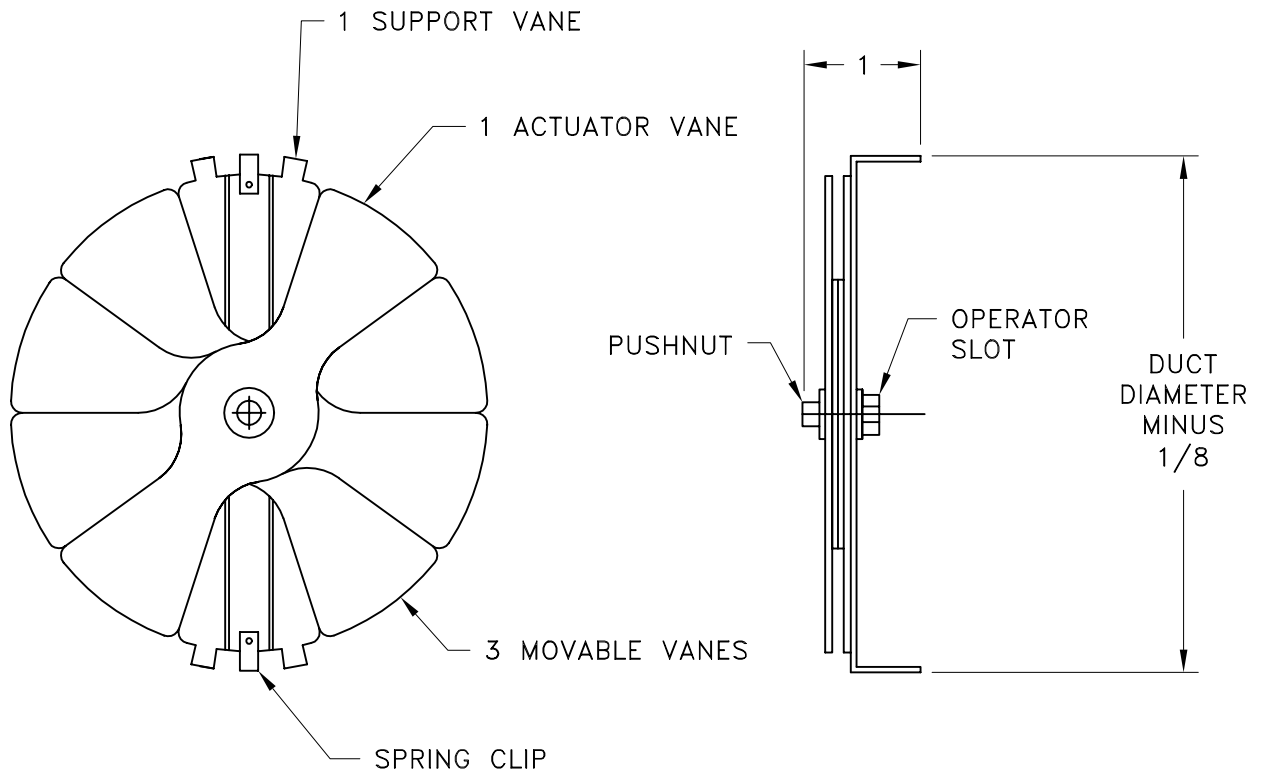

JOB NAME: _____	SUBMITTED BY: _____	DATE: 1/18/01	SD-9502
LOCATION: _____		RD Radial Blade Damper	
ARCHITECT: _____			
ENGINEER: _____			
CONTRACTOR: _____			