

- ALL STEEL CONSTRUCTION
- DESIGNED TO BLANKET WALLS AND WINDOWS FROM BASEBOARD INSTALLATIONS
- 38 SQUARE INCHES OF FREE AREA
- SNAP IN FACE FOR EASE OF INSTALLATION
- FINISH: WHITE (W) OR GOLDEN SAND (GS) ENAMEL

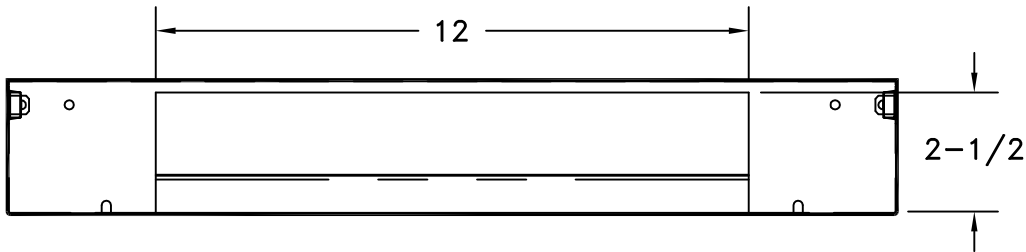
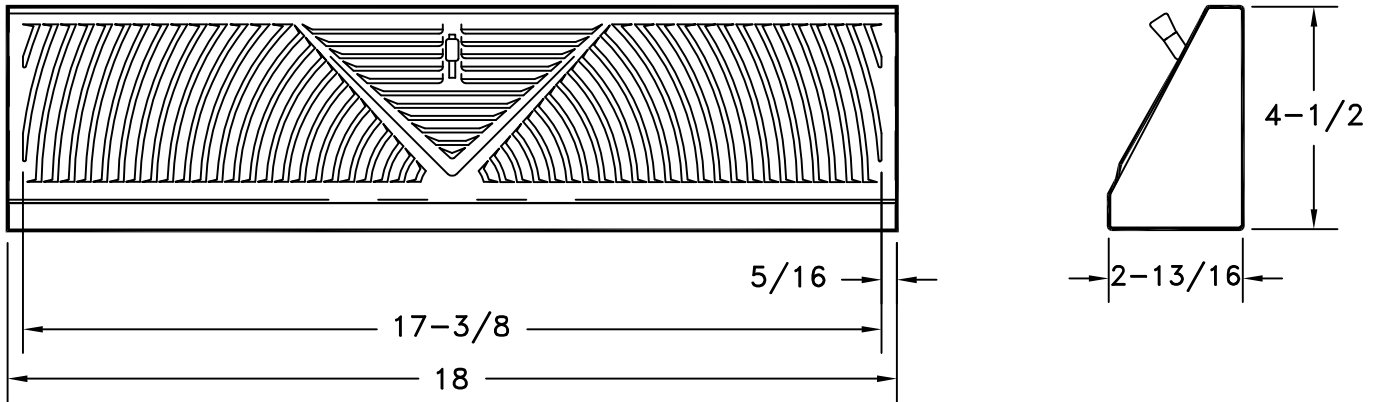

BOTTOM VIEW

JOB NAME: _____	SUBMITTED BY: _____	DATE: 01/30/08	SD-2010
LOCATION: _____		406 Baseboard Diffuser - 18"	
ARCHITECT: _____			
ENGINEER: _____			
CONTRACTOR: _____			