

Registers & Grilles - Steel



821

- All-steel construction
- Vertical adjustable face bars
- Horizontal multi-shutter valve
- Bright White finish

Note: Screw hole location details on page 117

821 Available Sizes (in.)											
HT	WIDTH										
	6	8	10	12	14	16	18	20	24	30	36
4	X	X	X	X	X	X	X	X	X	X	
5			X	X	X						
6	X	X	X	X	X	X	X	X	X	X	X
8		X	X	X	X	X	X	X	X	X	X
10			X	X	X	X	X	X	X	X	X
12				X	X	X	X	X	X	X	X
14					X	X	X	X	X	X	X
16						X	X	X	X	X	
18							X	X	X	X	
20								X			
24									X		

Contact factory for sizes not listed.

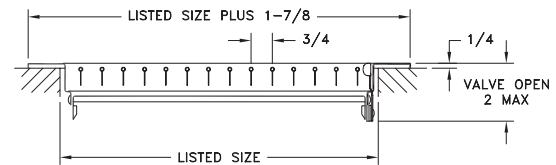

831

- All-steel construction
- Horizontal adjustable face bars
- Vertical valve
- Adjustable multi-shutter valve
- Bright White finish
- 3/4" fin spacing

Note: Screw hole location details on page 117

831 Available Sizes (in.)										
HT	WIDTH									
	8	10	12	14	16	20	24	30	32	36
4	X	X	X	X						
6	X	X	X	X	X	X	X	X		
8		X	X	X	X	X	X	X		
10			X			X	X			
12							X			X
14						X			X	

Contact factory for sizes not listed.

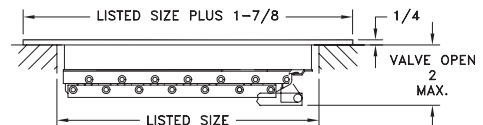



92HVO Grille

- All-steel construction
- Adjustable face bars may be set to any desired deflection
- Horizontal front bars
- Vertical second bars
- Larger sizes available in multiple-piece construction
- Bright White finish

Note: Screw hole location details on page 117

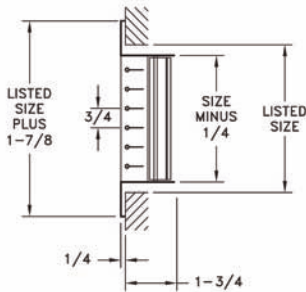

		92HVO Available Sizes (in.)															
		WIDTH															
HT		6	8	10	12	14	16	18	20	22	24	26	28	30	32	34	36
4		X	X	X	X	X	X	X	X	X	X	X	X	X	X	X	X
5		X	X	X	X	X	X	X	X	X	X	X	X	X	X	X	X
6		X	X	X	X	X	X	X	X	X	X	X	X	X	X	X	X
8			X	X	X	X	X	X	X	X	X	X	X	X	X	X	X
10				X	X	X	X	X	X	X	X	X	X	X	X	X	X
12					X	X	X	X	X	X	X	X	X	X	X	X	X
14						X	X	X	X	X	X	X	X	X	X	X	X
16							X	X	X	X	X	X	X	X	X	X	X
18								X	X	X	X	X	X	X	X	X	X
20									X	X	X	X	X	X	X	X	X
22										X	X	X	X	X	X	X	X
24											X	X	X	X	X	X	X
26												X	X	X	X	X	X
28													X	X	X	X	X
30														X	X	X	X
32															X	X	X
34																X	X
36																	X

Contact factory for sizes not listed.



92HVV Register

- All-steel construction
- Horizontal front bars
- Vertical second bars
- Opposed-blade damper
- Adjustable face bars may be set to any desired deflection
- Larger sizes available in multiple-piece construction
- Bright White finish

Note: Screw hole location details on page 117

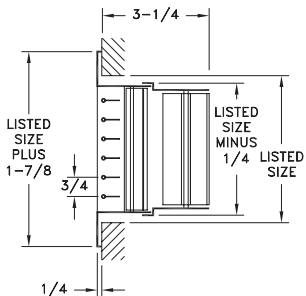

		92HVV Available Sizes (in.)															
		WIDTH															
HT		6	8	10	12	14	16	18	20	22	24	26	28	30	32	34	36
4		X	X	X	X	X	X	X	X	X	X	X	X	X	X	X	X
5		X	X	X	X	X	X	X	X	X	X	X	X	X	X	X	X
6		X	X	X	X	X	X	X	X	X	X	X	X	X	X	X	X
8			X	X	X	X	X	X	X	X	X	X	X	X	X	X	X
10				X	X	X	X	X	X	X	X	X	X	X	X	X	X
12					X	X	X	X	X	X	X	X	X	X	X	X	X
14						X	X	X	X	X	X	X	X	X	X	X	X
16							X	X	X	X	X	X	X	X	X	X	X
18								X	X	X	X	X	X	X	X	X	X
20									X	X	X	X	X	X	X	X	X
22										X	X	X	X	X	X	X	X
24											X	X	X	X	X	X	X
26												X	X	X	X	X	X
28													X	X	X	X	X
30														X	X	X	X
32															X	X	X
34																X	X
36																	X

Contact factory for sizes not listed.



92VHO Grille

- All-steel construction
- Vertical front bars
- Horizontal second bars
- Adjustable face bars may be set to any desired deflection
- Larger sizes available in multiple-piece construction
- Bright White finish

Note: Screw hole location details on page 117

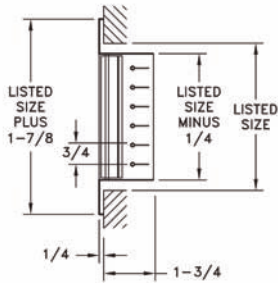

92VHO Available Sizes (in.)																
HT	WIDTH															
	6	8	10	12	14	16	18	20	22	24	26	28	30	32	34	36
4	X	X	X	X	X	X	X	X	X	X	X	X	X	X	X	X
5	X	X	X	X	X	X	X	X	X	X	X	X	X	X	X	X
6	X	X	X	X	X	X	X	X	X	X	X	X	X	X	X	X
8		X	X	X	X	X	X	X	X	X	X	X	X	X	X	X
10			X	X	X	X	X	X	X	X	X	X	X	X	X	X
12				X	X	X	X	X	X	X	X	X	X	X	X	X
14					X	X	X	X	X	X	X	X	X	X	X	X
16						X	X	X	X	X	X	X	X	X	X	X
18							X	X	X	X	X	X	X	X	X	X
20								X	X	X	X	X	X	X	X	X
22									X	X	X	X	X	X	X	X
24										X	X	X	X	X	X	X
26											X	X	X	X	X	X
28												X	X	X	X	X
30													X	X	X	X
32														X	X	X
34															X	X
36																X

Contact factory for sizes not listed.



92VHV Register

- All-steel construction
- Vertical front bars
- Horizontal second bars
- Adjustable face bars may be set to any desired deflection
- Opposed-blade damper
- Larger sizes available in multiple-piece construction
- Bright White finish

Note: Screw hole location details on page 117

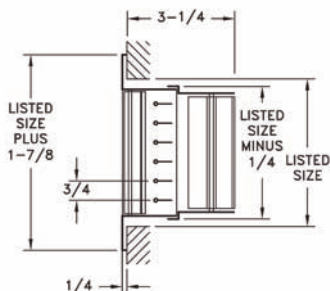

92VHV Available Sizes (in.)																
HT	WIDTH															
	6	8	10	12	14	16	18	20	22	24	26	28	30	32	34	36
4	X	X	X	X	X	X	X	X	X	X	X	X	X	X	X	X
5	X	X	X	X	X	X	X	X	X	X	X	X	X	X	X	X
6	X	X	X	X	X	X	X	X	X	X	X	X	X	X	X	X
8		X	X	X	X	X	X	X	X	X	X	X	X	X	X	X
10			X	X	X	X	X	X	X	X	X	X	X	X	X	X
12				X	X	X	X	X	X	X	X	X	X	X	X	X
14					X	X	X	X	X	X	X	X	X	X	X	X
16						X	X	X	X	X	X	X	X	X	X	X
18							X	X	X	X	X	X	X	X	X	X
20								X	X	X	X	X	X	X	X	X
22									X	X	X	X	X	X	X	X
24										X	X	X	X	X	X	X
26											X	X	X	X	X	X
28												X	X	X	X	X
30													X	X	X	X
32														X	X	X
34															X	X
36																X

Contact factory for sizes not listed.



94 Grille

- All-steel construction
- Horizontal face bars set straight
- Face bars permanently fixed into a heavy steel frame at 90-degree angle from face
- Larger sizes available in multiple-piece construction
- Bright White finish

Note: Screw hole location details on page 117

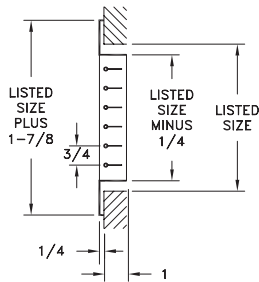

94 Available Sizes (in.)																
HT	WIDTH															
	6	8	10	12	14	16	18	20	22	24	26	28	30	32	34	36
4	X	X	X	X	X	X	X	X	X	X	X	X	X	X	X	X
5	X	X	X	X	X	X	X	X	X	X	X	X	X	X	X	X
6	X	X	X	X	X	X	X	X	X	X	X	X	X	X	X	X
8		X	X	X	X	X	X	X	X	X	X	X	X	X	X	X
10			X	X	X	X	X	X	X	X	X	X	X	X	X	X
12				X	X	X	X	X	X	X	X	X	X	X	X	X
14					X	X	X	X	X	X	X	X	X	X	X	X
16						X	X	X	X	X	X	X	X	X	X	X
18							X	X	X	X	X	X	X	X	X	X
20								X	X	X	X	X	X	X	X	X
22									X	X	X	X	X	X	X	X
24										X	X	X	X	X	X	X
26											X	X	X	X	X	X
28												X	X	X	X	X
30													X	X	X	X
32														X	X	X
34															X	X
36																X

Contact factory for sizes not listed.



94HOV Register

- All-steel construction
- Horizontal face bars set straight
- Face bars permanently fixed into a heavy steel frame at 90-degree angle from face
- Opposed-blade damper
- Larger sizes available in multiple-piece construction
- Bright White finish

Note: Screw hole location details on page 117

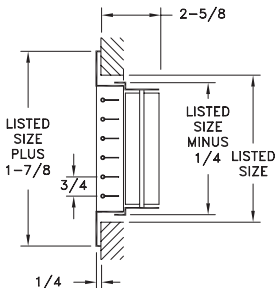

94HOV Available Sizes (in.)																
HT	WIDTH															
	6	8	10	12	14	16	18	20	22	24	26	28	30	32	34	36
4	X	X	X	X	X	X	X	X	X	X	X	X	X	X	X	X
5	X	X	X	X	X	X	X	X	X	X	X	X	X	X	X	X
6	X	X	X	X	X	X	X	X	X	X	X	X	X	X	X	X
8		X	X	X	X	X	X	X	X	X	X	X	X	X	X	X
10			X	X	X	X	X	X	X	X	X	X	X	X	X	X
12				X	X	X	X	X	X	X	X	X	X	X	X	X
14					X	X	X	X	X	X	X	X	X	X	X	X
16						X	X	X	X	X	X	X	X	X	X	X
18							X	X	X	X	X	X	X	X	X	X
20								X	X	X	X	X	X	X	X	X
22									X	X	X	X	X	X	X	X
24										X	X	X	X	X	X	X
26											X	X	X	X	X	X
28												X	X	X	X	X
30													X	X	X	X
32														X	X	X
34															X	X
36																X

Contact factory for sizes not listed.

Registers & Grilles - Steel



94A Grille (No Damper)

- All-steel construction
- 3/4" spaced fins set at 35°, horizontal face bars set at 35°
- Larger sizes available in multiple-piece construction
- Also available as 94AT T-Bar Return Grille (see page 57)
- Bright White finish

		94A Available Sizes (in.)																
		WIDTH																
HT		6	8	10	12	14	16	18	20	22	24	26	28	30	32	34	36	
4	X	X	X	X	X	X	X	X	X	X	X	X	X	X	X	X	X	
5	X	X	X	X	X	X	X	X	X	X	X	X	X	X	X	X	X	
6	X	X	X	X	X	X	X	X	X	X	X	X	X	X	X	X	X	
8		X	X	X	X	X	X	X	X	X	X	X	X	X	X	X	X	
10			X	X	X	X	X	X	X	X	X	X	X	X	X	X	X	
12				X	X	X	X	X	X	X	X	X	X	X	X	X	X	
14					X	X	X	X	X	X	X	X	X	X	X	X	X	
16						X	X	X	X	X	X	X	X	X	X	X	X	
18							X	X	X	X	X	X	X	X	X	X	X	
20								X	X	X	X	X	X	X	X	X	X	
22									X	X	X	X	X	X	X	X	X	
24										X	X	X	X	X	X	X	X	
26											X	X	X	X	X	X	X	
28												X	X	X	X	X	X	
30													X	X	X	X	X	
32														X	X	X	X	
34															X	X	X	
36																X	X	

Contact factory for sizes not listed.

Note: Screw hole location details on page 117

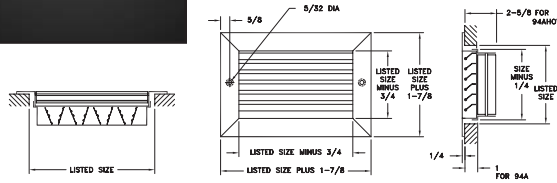

94AHOV Register

- All-steel construction
- 3/4" spaced fins set at 35°, horizontal face bars set at 35°
- Opposed-blade damper
- Larger sizes available in multiple-piece construction
- Bright White finish

		94AHOV Available Sizes (in.)																
		WIDTH																
HT		6	8	10	12	14	16	18	20	22	24	26	28	30	32	34	36	
4	X	X	X	X	X	X	X	X	X	X	X	X	X	X	X	X	X	
5	X	X	X	X	X	X	X	X	X	X	X	X	X	X	X	X	X	
6	X	X	X	X	X	X	X	X	X	X	X	X	X	X	X	X	X	
8	X	X	X	X	X	X	X	X	X	X	X	X	X	X	X	X	X	
10		X	X	X	X	X	X	X	X	X	X	X	X	X	X	X	X	
12			X	X	X	X	X	X	X	X	X	X	X	X	X	X	X	
14				X	X	X	X	X	X	X	X	X	X	X	X	X	X	
16					X	X	X	X	X	X	X	X	X	X	X	X	X	
18						X	X	X	X	X	X	X	X	X	X	X	X	
20							X	X	X	X	X	X	X	X	X	X	X	
22								X	X	X	X	X	X	X	X	X	X	
24									X	X	X	X	X	X	X	X	X	
26										X	X	X	X	X	X	X	X	
28											X	X	X	X	X	X	X	
30												X	X	X	X	X	X	
32													X	X	X	X	X	
34														X	X	X	X	
36															X	X	X	

Note: Screw hole location details on page 117

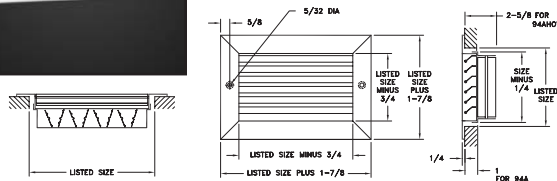

96AFB Fixed-Bar Filter Grille

- Steel construction
- Simplifies contractor installation
- Flush, removable face with concealed hinges
- Uses nominal 1" thick disposable filters (not included)
- 96AFB2 uses 2" thick disposable filters and is available by special order
- Equipped with adjustable filter retainers
- 3/4" spaced fins set at 35°
- Also available as 96AFBT T-Bar Fixed Bar Filter Grille (see page 88)
- Bright White finish

		96AFB Standard Sizes (in.)									
		WIDTH									
HT		10	12	14	16	18	20	24	25	30	36
10							X	X		X	
12			X				X	X		X	
14				X			X	X		X	
16					X		X	X		X	
18						X	X	X		X	
20	X	X	X	X			X	X	X	X	
24	X	X	X	X			X	X	X	X	X
25			X	X			X		X		
30				X			X	X		X	X
36											X

Contact factory for sizes not listed.

Note: Screw hole location details on page 117

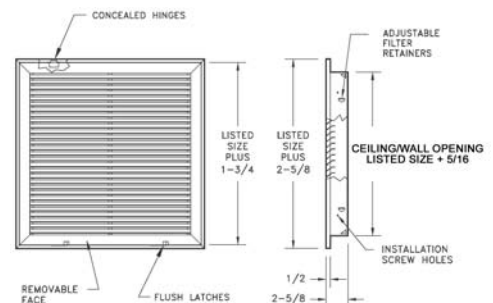

Engineering Data on Page 79



98VOH Ventilation Grille

- Steel construction
- Front bars are individually adjustable
- Horizontal blades are gang-operated to deflect air up or down thru face (no shut-off)
- Handle manually operated
- Bright White finish

HT	98VOH Available Sizes (in.)												
	WIDTH												
6	X	X	X	X	X	X	X	X	X	X	X	X	X
8	X	X	X	X	X	X	X	X	X	X	X	X	X
10	X	X	X	X	X	X	X	X	X	X	X	X	X
12		X	X	X	X	X	X	X	X	X	X	X	X
14			X	X	X	X	X	X	X	X	X	X	X
16				X	X	X	X	X	X	X	X	X	X
18					X	X	X	X	X	X	X	X	X
20						X	X	X	X	X	X	X	X
22							X	X	X	X	X	X	X
24								X	X	X	X	X	X
26									X	X	X	X	X
28										X	X	X	X
30											X	X	X
32												X	X
34													X
36													

Note: Screw hole location details on page 117

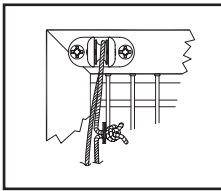

Detail of optional pulley (98VOHP) for remote adjustment of deflection louvers. Field-installed center pulley over lever.

98VOHP Ventilation Grille

- Pulley field-mounted only
- Pulley assembly must be ordered separately
- Pulley operation allows air deflection adjustments from floor
- Two pulley assemble kits required for grilles over 24" wide

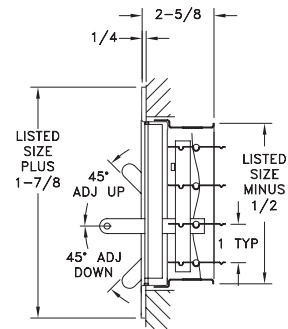

9200V Damper

- Steel construction
- Opposed-blade damper
- Controls the air volume from full flow to shut-off
- Mill finish

9200V Available Sizes (in.)
Minimum: 6" x 4"
Maximum: 24" x 24" One Piece

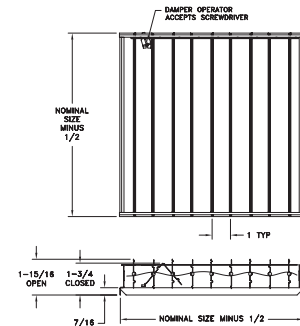

PFG Perforated Face Grille

- All steel construction
- Perforated face
- Optional opposed blade damper
- Optional T-Bar lay-in frames
- Bright white finish

PFG Available Sizes (in.)
Minimum: 6" x 4"
Maximum: 48" x 48" One Piece

Note: Screw hole location details on page 117

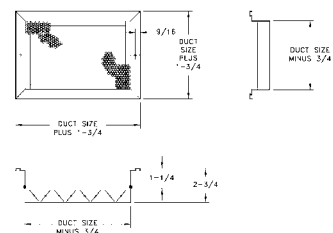



Note: Screw hole location details on page 117

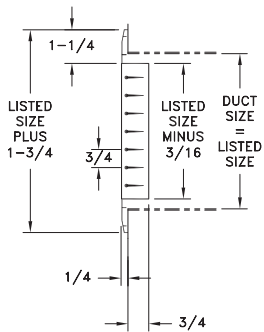

HX Grille

- Extruded aluminum construction
- Horizontal front bars
- Single row of individually adjustable horizontal face bars
- Pivoted bars for easy positive setting
- Bright White or Satin Anodized finish

		HX Available Sizes (in.)																			
		WIDTH																			
HT	WIDTH																				
	4	X	X	X	X	X	X	X	X	X	X	X	X	X	X	X	X	X	X	X	X
5	X	X	X	X	X	X	X	X	X	X	X	X	X	X	X	X	X	X	X	X	
6	X	X	X	X	X	X	X	X	X	X	X	X	X	X	X	X	X	X	X	X	
8	X	X	X	X	X	X	X	X	X	X	X	X	X	X	X	X	X	X	X	X	
10			X	X	X	X	X	X	X	X	X	X	X	X	X	X	X	X	X	X	
12				X	X	X	X	X	X	X	X	X	X	X	X	X	X	X	X	X	
14					X	X	X	X	X	X	X	X	X	X	X	X	X	X	X	X	
16						X	X	X	X	X	X	X	X	X	X	X	X	X	X	X	
18							X	X	X	X	X	X	X	X	X	X	X	X	X	X	
20								X	X	X	X	X	X	X	X	X	X	X	X	X	
22									X	X	X	X	X	X	X	X	X	X	X	X	
24										X	X	X	X	X	X	X	X	X	X	X	
26											X	X	X	X	X	X	X	X	X	X	
28												X	X	X	X	X	X	X	X	X	
30													X	X	X	X	X	X	X	X	
32														X	X	X	X	X	X	X	
34															X	X	X	X	X	X	
36																X	X	X	X	X	
38																	X	X	X	X	
40																		X	X	X	
42																			X	X	
44																				X	
46																				X	
48																				X	

Other sizes available upon request



Note: Screw hole location details on page 117

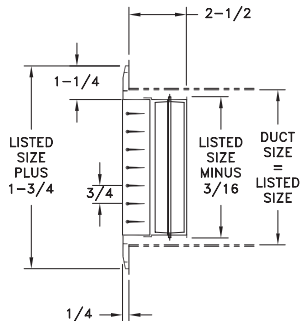

HD Register

- Extruded aluminum construction
- Single row of individually adjustable horizontal face bars
- Pivoted bars for easy positive setting
- Opposed-blade damper
- Bright White or Satin Anodized finish

		HD Available Sizes (in.)																			
		WIDTH																			
HT	WIDTH																				
	4	X	X	X	X	X	X	X	X	X	X	X	X	X	X	X	X	X	X	X	X
5	X	X	X	X	X	X	X	X	X	X	X	X	X	X	X	X	X	X	X	X	
6	X	X	X	X	X	X	X	X	X	X	X	X	X	X	X	X	X	X	X	X	
8	X	X	X	X	X	X	X	X	X	X	X	X	X	X	X	X	X	X	X	X	
10		X	X	X	X	X	X	X	X	X	X	X	X	X	X	X	X	X	X	X	
12			X	X	X	X	X	X	X	X	X	X	X	X	X	X	X	X	X	X	
14				X	X	X	X	X	X	X	X	X	X	X	X	X	X	X	X	X	
16					X	X	X	X	X	X	X	X	X	X	X	X	X	X	X	X	
18						X	X	X	X	X	X	X	X	X	X	X	X	X	X	X	
20							X	X	X	X	X	X	X	X	X	X	X	X	X	X	
22								X	X	X	X	X	X	X	X	X	X	X	X	X	
24									X	X	X	X	X	X	X	X	X	X	X	X	
26										X	X	X	X	X	X	X	X	X	X	X	
28											X	X	X	X	X	X	X	X	X	X	
30												X	X	X	X	X	X	X	X	X	
32													X	X	X	X	X	X	X	X	
34														X	X	X	X	X	X	X	
36															X	X	X	X	X	X	
38																X	X	X	X	X	
40																	X	X	X	X	
42																		X	X	X	
44																			X	X	
46																				X	
48																				X	

Other sizes available upon request



HM Register

- Extruded aluminum construction
- Single row of individually adjustable horizontal face bars
- Pivoted bars for easy positive setting
- Lever-operated, multi-shutter valve
- Bright White or Satin Anodized finish

Note: Screw hole location details on page 117

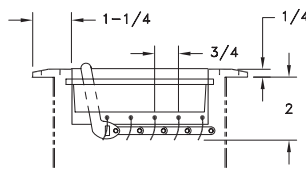
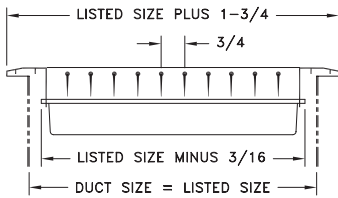

HT		HM Available Sizes (in.)															
		WIDTH															
4	X	X	X	X	X	X	X	X	X	X	X	X	X	X	X	X	
5	X	X	X	X	X	X	X	X	X	X	X	X	X	X	X	X	
6	X	X	X	X	X	X	X	X	X	X	X	X	X	X	X	X	
8		X	X	X	X	X	X	X	X	X	X	X	X	X	X	X	
10			X	X	X	X	X	X	X	X	X	X	X	X	X	X	
12				X	X	X	X	X	X	X	X	X	X	X	X	X	
14					X	X	X	X	X	X	X	X	X	X	X	X	
16						X	X	X	X	X	X	X	X	X	X	X	
18							X	X	X	X	X	X	X	X	X	X	
20								X	X	X	X	X	X	X	X	X	
22									X	X	X	X	X	X	X	X	
24										X	X	X	X	X	X	X	
26											X	X	X	X	X	X	
28												X	X	X	X	X	
30													X	X	X	X	
32														X	X	X	
34															X	X	
36																X	

Other sizes available upon request



HV Grille

- Extruded aluminum construction
- Horizontal front bars
- Vertical second bars
- Two rows of individually adjusted face bars for horizontal and vertical deflection
- Pivoted bars for easy positive setting
- Bright White or Satin Anodized finish

Note: Screw hole location details on page 117

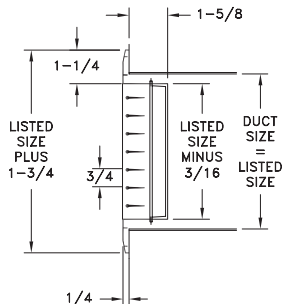

HT		HV Available Sizes (in.)																			
		WIDTH																			
4	X	X	X	X	X	X	X	X	X	X	X	X	X	X	X	X	X	X	X	X	
5	X	X	X	X	X	X	X	X	X	X	X	X	X	X	X	X	X	X	X	X	
6	X	X	X	X	X	X	X	X	X	X	X	X	X	X	X	X	X	X	X	X	
8		X	X	X	X	X	X	X	X	X	X	X	X	X	X	X	X	X	X	X	
10			X	X	X	X	X	X	X	X	X	X	X	X	X	X	X	X	X	X	
12				X	X	X	X	X	X	X	X	X	X	X	X	X	X	X	X	X	
14					X	X	X	X	X	X	X	X	X	X	X	X	X	X	X	X	
16						X	X	X	X	X	X	X	X	X	X	X	X	X	X	X	
18							X	X	X	X	X	X	X	X	X	X	X	X	X	X	
20								X	X	X	X	X	X	X	X	X	X	X	X	X	
22									X	X	X	X	X	X	X	X	X	X	X	X	
24										X	X	X	X	X	X	X	X	X	X	X	
26											X	X	X	X	X	X	X	X	X	X	
28												X	X	X	X	X	X	X	X	X	
30													X	X	X	X	X	X	X	X	
32														X	X	X	X	X	X	X	
34															X	X	X	X	X	X	
36																X	X	X	X	X	
38																	X	X	X	X	
40																		X	X	X	
42																			X	X	
44																				X	
46																				X	
48																				X	

Other sizes available upon request

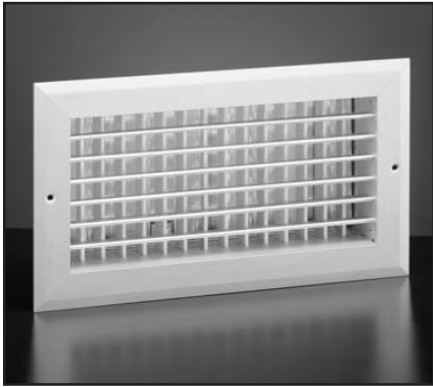

HVD Register

- Extruded aluminum construction
- Two rows of individually adjusted face bars for horizontal and vertical deflection
- Pivoted bars for easy positive setting
- Opposed-blade damper
- Bright White or Satin Anodized finish

Note: Screw hole location details on page 117

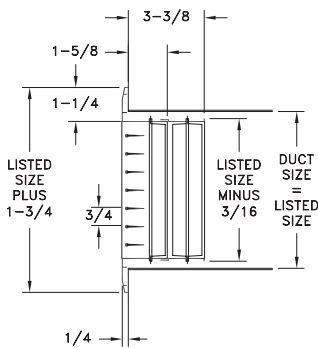

HT		HVD Available Sizes (in.)																		
		WIDTH																		
4	X	X	X	X	X	X	X	X	X	X	X	X	X	X	X	X	X	X	X	X
5	X	X	X	X	X	X	X	X	X	X	X	X	X	X	X	X	X	X	X	X
6	X	X	X	X	X	X	X	X	X	X	X	X	X	X	X	X	X	X	X	X
8	X	X	X	X	X	X	X	X	X	X	X	X	X	X	X	X	X	X	X	X
10		X	X	X	X	X	X	X	X	X	X	X	X	X	X	X	X	X	X	X
12			X	X	X	X	X	X	X	X	X	X	X	X	X	X	X	X	X	X
14				X	X	X	X	X	X	X	X	X	X	X	X	X	X	X	X	X
16					X	X	X	X	X	X	X	X	X	X	X	X	X	X	X	X
18						X	X	X	X	X	X	X	X	X	X	X	X	X	X	X
20							X	X	X	X	X	X	X	X	X	X	X	X	X	X
22								X	X	X	X	X	X	X	X	X	X	X	X	X
24									X	X	X	X	X	X	X	X	X	X	X	X
26										X	X	X	X	X	X	X	X	X	X	X
28											X	X	X	X	X	X	X	X	X	X
30												X	X	X	X	X	X	X	X	X
32													X	X	X	X	X	X	X	X
34														X	X	X	X	X	X	X
36															X	X	X	X	X	X
38																X	X	X	X	X
40																	X	X	X	X
42																		X	X	X
44																			X	X
46																				X
48																				X

Other sizes available upon request



VX Grille

- Extruded aluminum construction
- Vertical front bars
- Single row of individually adjustable face bars
- Pivoted bars for easy positive setting
- Bright White or Satin Anodized finish

Note: Screw hole location details on page 117

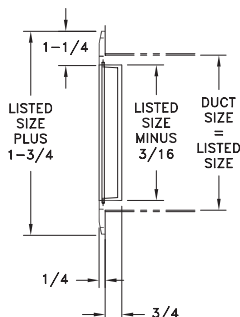

HT		VX Available Sizes (in.)																		
		WIDTH																		
4	X	X	X	X	X	X	X	X	X	X	X	X	X	X	X	X	X	X	X	X
5	X	X	X	X	X	X	X	X	X	X	X	X	X	X	X	X	X	X	X	X
6	X	X	X	X	X	X	X	X	X	X	X	X	X	X	X	X	X	X	X	X
8	X	X	X	X	X	X	X	X	X	X	X	X	X	X	X	X	X	X	X	X
10		X	X	X	X	X	X	X	X	X	X	X	X	X	X	X	X	X	X	X
12			X	X	X	X	X	X	X	X	X	X	X	X	X	X	X	X	X	X
14				X	X	X	X	X	X	X	X	X	X	X	X	X	X	X	X	X
16					X	X	X	X	X	X	X	X	X	X	X	X	X	X	X	X
18						X	X	X	X	X	X	X	X	X	X	X	X	X	X	X
20							X	X	X	X	X	X	X	X	X	X	X	X	X	X
22								X	X	X	X	X	X	X	X	X	X	X	X	X
24									X	X	X	X	X	X	X	X	X	X	X	X
26										X	X	X	X	X	X	X	X	X	X	X
28											X	X	X	X	X	X	X	X	X	X
30												X	X	X	X	X	X	X	X	X
32													X	X	X	X	X	X	X	X
34														X	X	X	X	X	X	X
36															X	X	X	X	X	X
38																X	X	X	X	X
40																	X	X	X	X
42																		X	X	X
44																			X	X
46																				X
48																				X

Other sizes available upon request



VD Register

- Extruded aluminum construction
- Vertical front bars
- Single row of individually adjustable face bars
- Pivoted bars for easy positive setting
- Opposed-blade damper
- Bright White or Satin Anodized finish

Note: Screw hole location details on page 117

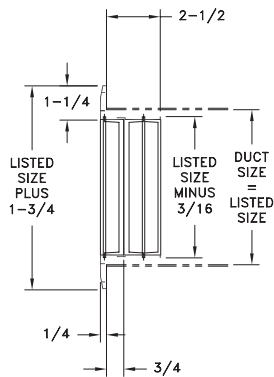

		VD Available Sizes (in.)																					
		WIDTH																					
HT	6	8	10	12	14	16	18	20	22	24	26	28	30	32	34	36	38	40	42	44	46	48	
	4	X	X	X	X	X	X	X	X	X	X	X	X	X	X	X	X	X	X	X	X	X	X
5	X	X	X	X	X	X	X	X	X	X	X	X	X	X	X	X	X	X	X	X	X	X	X
6	X	X	X	X	X	X	X	X	X	X	X	X	X	X	X	X	X	X	X	X	X	X	X
8	X	X	X	X	X	X	X	X	X	X	X	X	X	X	X	X	X	X	X	X	X	X	X
10		X	X	X	X	X	X	X	X	X	X	X	X	X	X	X	X	X	X	X	X	X	X
12			X	X	X	X	X	X	X	X	X	X	X	X	X	X	X	X	X	X	X	X	X
14				X	X	X	X	X	X	X	X	X	X	X	X	X	X	X	X	X	X	X	X
16					X	X	X	X	X	X	X	X	X	X	X	X	X	X	X	X	X	X	X
18						X	X	X	X	X	X	X	X	X	X	X	X	X	X	X	X	X	X
20							X	X	X	X	X	X	X	X	X	X	X	X	X	X	X	X	X
22								X	X	X	X	X	X	X	X	X	X	X	X	X	X	X	X
24									X	X	X	X	X	X	X	X	X	X	X	X	X	X	X
26										X	X	X	X	X	X	X	X	X	X	X	X	X	X
28											X	X	X	X	X	X	X	X	X	X	X	X	X
30												X	X	X	X	X	X	X	X	X	X	X	X
32													X	X	X	X	X	X	X	X	X	X	X
34														X	X	X	X	X	X	X	X	X	X
36															X	X	X	X	X	X	X	X	X
38																X	X	X	X	X	X	X	X
40																	X	X	X	X	X	X	X
42																		X	X	X	X	X	X
44																			X	X	X	X	X
46																				X	X	X	X
48																					X	X	X

Other sizes available upon request



VM Register

- Extruded aluminum construction
- Vertical front bars
- Pivoted bars for easy positive setting
- Lever-operated, multi-shutter valve
- Single row of individually adjusted face bars
- Horizontal valve blades
- Bright White or Satin Anodized finish

Note: Screw hole location details on page 117

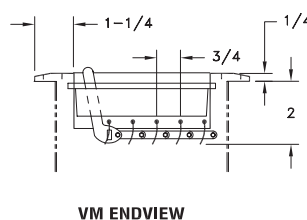
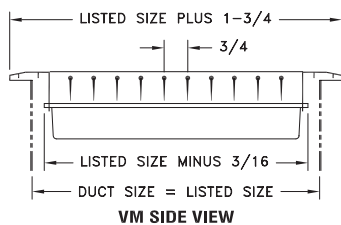

		VM Available Sizes (in.)														
		WIDTH														
HT	6	8	10	12	14	16	18	20	22	24	26	28	30	32	34	36
	4	X	X	X	X	X	X	X	X	X	X	X	X	X	X	X
5	X	X	X	X	X	X	X	X	X	X	X	X	X	X	X	X
6	X	X	X	X	X	X	X	X	X	X	X	X	X	X	X	X
8	X	X	X	X	X	X	X	X	X	X	X	X	X	X	X	X
10		X	X	X	X	X	X	X	X	X	X	X	X	X	X	X
12			X	X	X	X	X	X	X	X	X	X	X	X	X	X
14				X	X	X	X	X	X	X	X	X	X	X	X	X
16					X	X	X	X	X	X	X	X	X	X	X	X
18						X	X	X	X	X	X	X	X	X	X	X
20							X	X	X	X	X	X	X	X	X	X
22								X	X	X	X	X	X	X	X	X
24									X	X	X	X	X	X	X	X
26										X	X	X	X	X	X	X
28											X	X	X	X	X	X
30												X	X	X	X	X
32													X	X	X	X
34														X	X	X
36															X	X

Other sizes available upon request



VH Grille

- Extruded aluminum construction
- Vertical front bars
- Horizontal second bars
- Two rows of individually adjusted face bars for horizontal and vertical deflection
- Pivoted bars for easy positive setting
- Bright White or Satin Anodized finish

Note: Screw hole location details on page 117

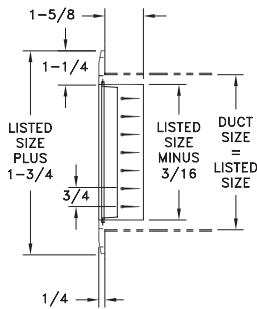

		VH Available Sizes (in.)																				
		WIDTH																				
HT	6	8	10	12	14	16	18	20	22	24	26	28	30	32	34	36	38	40	42	44	46	48
	4	X	X	X	X	X	X	X	X	X	X	X	X	X	X	X	X	X	X	X	X	X
5	X	X	X	X	X	X	X	X	X	X	X	X	X	X	X	X	X	X	X	X	X	X
6	X	X	X	X	X	X	X	X	X	X	X	X	X	X	X	X	X	X	X	X	X	X
8		X	X	X	X	X	X	X	X	X	X	X	X	X	X	X	X	X	X	X	X	X
10			X	X	X	X	X	X	X	X	X	X	X	X	X	X	X	X	X	X	X	X
12				X	X	X	X	X	X	X	X	X	X	X	X	X	X	X	X	X	X	X
14					X	X	X	X	X	X	X	X	X	X	X	X	X	X	X	X	X	X
16						X	X	X	X	X	X	X	X	X	X	X	X	X	X	X	X	X
18							X	X	X	X	X	X	X	X	X	X	X	X	X	X	X	X
20								X	X	X	X	X	X	X	X	X	X	X	X	X	X	X
22									X	X	X	X	X	X	X	X	X	X	X	X	X	X
24										X	X	X	X	X	X	X	X	X	X	X	X	X
26											X	X	X	X	X	X	X	X	X	X	X	X
28												X	X	X	X	X	X	X	X	X	X	X
30													X	X	X	X	X	X	X	X	X	X
32														X	X	X	X	X	X	X	X	X
34															X	X	X	X	X	X	X	X
36																X	X	X	X	X	X	X
38																	X	X	X	X	X	X
40																		X	X	X	X	X
42																			X	X	X	X
44																				X	X	X
46																					X	X
48																						X

Other sizes available upon request



VHD Register

- Extruded aluminum construction
- Vertical front bars
- Horizontal second bars
- Two rows of individually adjusted face bars for horizontal and vertical deflection
- Pivoted bars for easy positive setting
- Opposed-blade damper
- Bright White or Satin Anodized finish

Note: Screw hole location details on page 117

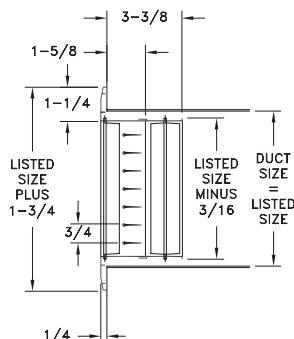

		VHD Available Sizes (in.)																				
		WIDTH																				
HT	6	8	10	12	14	16	18	20	22	24	26	28	30	32	34	36	38	40	42	44	46	48
	4	X	X	X	X	X	X	X	X	X	X	X	X	X	X	X	X	X	X	X	X	X
5	X	X	X	X	X	X	X	X	X	X	X	X	X	X	X	X	X	X	X	X	X	X
6	X	X	X	X	X	X	X	X	X	X	X	X	X	X	X	X	X	X	X	X	X	X
8		X	X	X	X	X	X	X	X	X	X	X	X	X	X	X	X	X	X	X	X	X
10			X	X	X	X	X	X	X	X	X	X	X	X	X	X	X	X	X	X	X	X
12				X	X	X	X	X	X	X	X	X	X	X	X	X	X	X	X	X	X	X
14					X	X	X	X	X	X	X	X	X	X	X	X	X	X	X	X	X	X
16						X	X	X	X	X	X	X	X	X	X	X	X	X	X	X	X	X
18							X	X	X	X	X	X	X	X	X	X	X	X	X	X	X	X
20								X	X	X	X	X	X	X	X	X	X	X	X	X	X	X
22									X	X	X	X	X	X	X	X	X	X	X	X	X	X
24										X	X	X	X	X	X	X	X	X	X	X	X	X
26											X	X	X	X	X	X	X	X	X	X	X	X
28												X	X	X	X	X	X	X	X	X	X	X
30													X	X	X	X	X	X	X	X	X	X
32														X	X	X	X	X	X	X	X	X
34															X	X	X	X	X	X	X	X
36																X	X	X	X	X	X	X
38																	X	X	X	X	X	X
40																		X	X	X	X	X
42																			X	X	X	X
44																				X	X	X
46																					X	X
48																						X

Other sizes available upon request



Note: Screw hole location details on page 117

CH1 Grille

- Extruded aluminum construction
- One-way deflection
- Individually adjustable curved-face bars
- Pivoted bars for easy positive setting
- Bright White or Satin Anodized finish

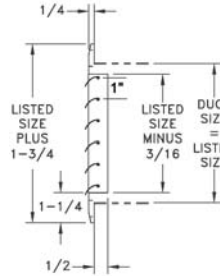

		CH1 Available Sizes (in.)															
HT	WIDTH																
	6	8	10	12	14	16	18	20	22	24	26	28	30	32	34	36	
6	X	X	X	X	X	X	X	X	X	X	X	X	X	X	X	X	
8		X	X	X	X	X	X	X	X	X	X	X	X	X	X	X	
10			X	X	X	X	X	X	X	X	X	X	X	X	X	X	
12				X	X	X	X	X	X	X	X	X	X	X	X	X	
14					X	X	X	X	X	X	X	X	X	X	X	X	
16						X	X	X	X	X	X	X	X	X	X	X	
18							X	X	X	X	X	X	X	X	X	X	
20								X	X	X	X	X	X	X	X	X	
22									X	X	X	X	X	X	X	X	
24										X	X	X	X	X	X	X	
26											X	X	X	X	X	X	
28												X	X	X	X	X	
30													X	X	X	X	
32														X	X	X	
34															X	X	
36																X	

Other sizes available upon request



Note: Screw hole location details on page 117

CHD1 Register

- Extruded aluminum construction
- One-way deflection
- Individually adjustable curved-face bars
- Pivoted bars for easy positive setting
- Opposed-blade damper
- Bright White or Satin Anodized finish

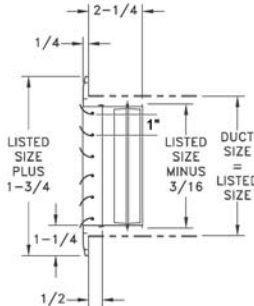

		CHD1 Available Sizes (in.)															
HT	WIDTH																
	6	8	10	12	14	16	18	20	22	24	26	28	30	32	34	36	
6	X	X	X	X	X	X	X	X	X	X	X	X	X	X	X	X	
8		X	X	X	X	X	X	X	X	X	X	X	X	X	X	X	
10			X	X	X	X	X	X	X	X	X	X	X	X	X	X	
12				X	X	X	X	X	X	X	X	X	X	X	X	X	
14					X	X	X	X	X	X	X	X	X	X	X	X	
16						X	X	X	X	X	X	X	X	X	X	X	
18							X	X	X	X	X	X	X	X	X	X	
20								X	X	X	X	X	X	X	X	X	
22									X	X	X	X	X	X	X	X	
24										X	X	X	X	X	X	X	
26											X	X	X	X	X	X	
28												X	X	X	X	X	
30													X	X	X	X	
32														X	X	X	
34															X	X	
36																X	

Other sizes available upon request



Note: Screw hole location details on page 117

CHM1 Register

- Extruded aluminum construction
- One-way deflection
- Individually adjustable curved-face bars
- Pivoted bars for easy positive setting
- Multi-shutter valve
- Bright White or Satin Anodized finish

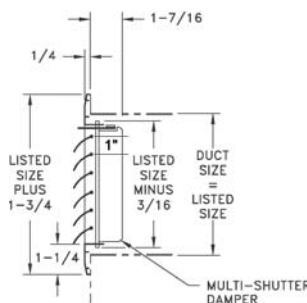

		CHM1 Available Sizes (in.)															
HT	WIDTH																
	6	8	10	12	14	16	18	20	22	24	26	28	30	32	34	36	
6	X	X	X	X	X	X	X	X	X	X	X	X	X	X	X	X	
8		X	X	X	X	X	X	X	X	X	X	X	X	X	X	X	
10			X	X	X	X	X	X	X	X	X	X	X	X	X	X	
12				X	X	X	X	X	X	X	X	X	X	X	X	X	
14					X	X	X	X	X	X	X	X	X	X	X	X	
16						X	X	X	X	X	X	X	X	X	X	X	
18							X	X	X	X	X	X	X	X	X	X	
20								X	X	X	X	X	X	X	X	X	
22									X	X	X	X	X	X	X	X	
24										X	X	X	X	X	X	X	
26											X	X	X	X	X	X	
28												X	X	X	X	X	
30													X	X	X	X	
32														X	X	X	
34															X	X	
36																X	

Other sizes available upon request



CH2 Grille

- Extruded aluminum construction
- Two-way deflection
- Individually adjustable curved-face bars
- Pivoted bars for easy positive setting
- Bright White or Satin Anodized finish

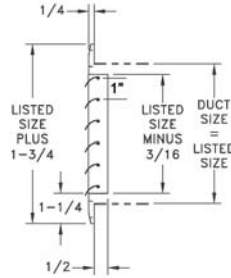

Note: Screw hole location details on page 117

		CH2 Available Sizes (in.)															
		WIDTH															
HT	6	8	10	12	14	16	18	20	22	24	26	28	30	32	34	36	
	6	X	X	X	X	X	X	X	X	X	X	X	X	X	X	X	X
8		X	X	X	X	X	X	X	X	X	X	X	X	X	X	X	
10			X	X	X	X	X	X	X	X	X	X	X	X	X	X	
12				X	X	X	X	X	X	X	X	X	X	X	X	X	
14					X	X	X	X	X	X	X	X	X	X	X	X	
16						X	X	X	X	X	X	X	X	X	X	X	
18							X	X	X	X	X	X	X	X	X	X	
20								X	X	X	X	X	X	X	X	X	
22									X	X	X	X	X	X	X	X	
24										X	X	X	X	X	X	X	
26											X	X	X	X	X	X	
28												X	X	X	X	X	
30													X	X	X	X	
32														X	X	X	
34															X	X	
36																X	

Other sizes available upon request



CHD2 Register

- Extruded aluminum construction
- Two-way deflection
- Individually adjustable curved-face bars
- Pivoted bars for easy positive setting
- Opposed-blade damper
- Bright White or Satin Anodized finish

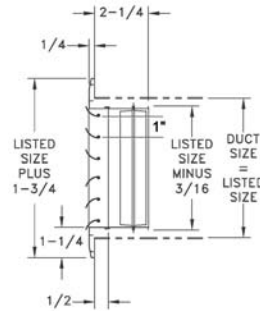

Note: Screw hole location details on page 117

		CHD2 Available Sizes (in.)															
		WIDTH															
HT	6	8	10	12	14	16	18	20	22	24	26	28	30	32	34	36	
	6	X	X	X	X	X	X	X	X	X	X	X	X	X	X	X	X
8		X	X	X	X	X	X	X	X	X	X	X	X	X	X	X	
10			X	X	X	X	X	X	X	X	X	X	X	X	X	X	
12				X	X	X	X	X	X	X	X	X	X	X	X	X	
14					X	X	X	X	X	X	X	X	X	X	X	X	
16						X	X	X	X	X	X	X	X	X	X	X	
18							X	X	X	X	X	X	X	X	X	X	
20								X	X	X	X	X	X	X	X	X	
22									X	X	X	X	X	X	X	X	
24										X	X	X	X	X	X	X	
26											X	X	X	X	X	X	
28												X	X	X	X	X	
30													X	X	X	X	
32														X	X	X	
34															X	X	
36																X	

Other sizes available upon request



CHM2 Register

- Extruded aluminum construction
- Two-way deflection
- Individually adjustable curved-face bars
- Pivoted bars for easy positive setting
- Multi-shutter valve
- Bright White or Satin Anodized finish

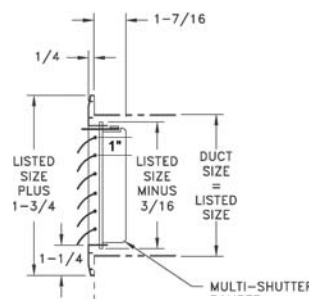

Note: Screw hole location details on page 117

		CHM2 Available Sizes (in.)															
		WIDTH															
HT	6	8	10	12	14	16	18	20	22	24	26	28	30	32	34	36	
	6	X	X	X	X	X	X	X	X	X	X	X	X	X	X	X	X
8		X	X	X	X	X	X	X	X	X	X	X	X	X	X	X	
10			X	X	X	X	X	X	X	X	X	X	X	X	X	X	
12				X	X	X	X	X	X	X	X	X	X	X	X	X	
14					X	X	X	X	X	X	X	X	X	X	X	X	
16						X	X	X	X	X	X	X	X	X	X	X	
18							X	X	X	X	X	X	X	X	X	X	
20								X	X	X	X	X	X	X	X	X	
22									X	X	X	X	X	X	X	X	
24										X	X	X	X	X	X	X	
26											X	X	X	X	X	X	
28												X	X	X	X	X	
30													X	X	X	X	
32														X	X	X	
34															X	X	
36																X	

Other sizes available upon request



C3 Grille

- Extruded aluminum construction
- Three-way deflection
- Individually adjustable curved-face bars
- Pivoted bars for easy positive setting
- Bright White or Satin Anodized finish

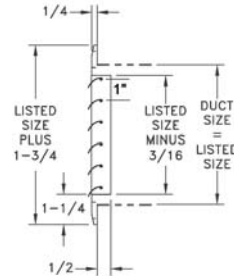

Note: Screw hole location details on page 117

		C3 Available Sizes (in.)															
		WIDTH															
HT	6	8	10	12	14	16	18	20	22	24	26	28	30	32	34	36	
	6	X	X	X	X	X	X	X	X	X	X	X	X	X	X	X	X
8		X	X	X	X	X	X	X	X	X	X	X	X	X	X	X	
10			X	X	X	X	X	X	X	X	X	X	X	X	X	X	
12				X	X	X	X	X	X	X	X	X	X	X	X	X	
14					X	X	X	X	X	X	X	X	X	X	X	X	
16						X	X	X	X	X	X	X	X	X	X	X	
18							X	X	X	X	X	X	X	X	X	X	
20								X	X	X	X	X	X	X	X	X	
22									X	X	X	X	X	X	X	X	
24										X	X	X	X	X	X	X	
26											X	X	X	X	X	X	
28												X	X	X	X	X	
30													X	X	X	X	
32														X	X	X	
34															X	X	
36																X	

Other sizes available upon request



CD3 Register

- Extruded aluminum construction
- Three-way deflection
- Individually adjustable curved-face bars
- Pivoted bars for easy positive setting
- Opposed-blade damper
- Bright White or Satin Anodized finish

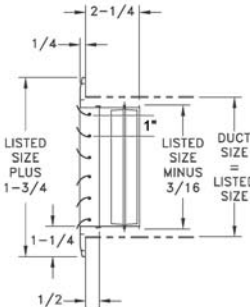

Note: Screw hole location details on page 117

		CD3 Available Sizes (in.)															
		WIDTH															
HT	6	8	10	12	14	16	18	20	22	24	26	28	30	32	34	36	
	6	X	X	X	X	X	X	X	X	X	X	X	X	X	X	X	X
8		X	X	X	X	X	X	X	X	X	X	X	X	X	X	X	
10			X	X	X	X	X	X	X	X	X	X	X	X	X	X	
12				X	X	X	X	X	X	X	X	X	X	X	X	X	
14					X	X	X	X	X	X	X	X	X	X	X	X	
16						X	X	X	X	X	X	X	X	X	X	X	
18							X	X	X	X	X	X	X	X	X	X	
20								X	X	X	X	X	X	X	X	X	
22									X	X	X	X	X	X	X	X	
24										X	X	X	X	X	X	X	
26											X	X	X	X	X	X	
28												X	X	X	X	X	
30													X	X	X	X	
32														X	X	X	
34															X	X	
36																X	

Other sizes available upon request



CM3 Register

- Extruded aluminum construction
- Three-way deflection
- Individually adjustable curved-face bars
- Pivoted bars for easy positive setting
- Multi-shutter valve
- Bright White or Satin Anodized finish

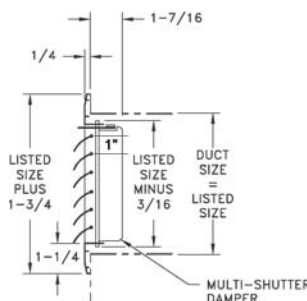

Note: Screw hole location details on page 117

		CM3 Available Sizes (in.)															
		WIDTH															
HT	6	8	10	12	14	16	18	20	22	24	26	28	30	32	34	36	
	6	X	X	X	X	X	X	X	X	X	X	X	X	X	X	X	X
8		X	X	X	X	X	X	X	X	X	X	X	X	X	X	X	
10			X	X	X	X	X	X	X	X	X	X	X	X	X	X	
12				X	X	X	X	X	X	X	X	X	X	X	X	X	
14					X	X	X	X	X	X	X	X	X	X	X	X	
16						X	X	X	X	X	X	X	X	X	X	X	
18							X	X	X	X	X	X	X	X	X	X	
20								X	X	X	X	X	X	X	X	X	
22									X	X	X	X	X	X	X	X	
24										X	X	X	X	X	X	X	
26											X	X	X	X	X	X	
28												X	X	X	X	X	
30													X	X	X	X	
32														X	X	X	
34															X	X	
36																X	

Other sizes available upon request



C4 Grille

- Extruded aluminum construction
- Four-way deflection
- Individually adjustable curved-face bars
- Pivoted bars for easy positive setting
- Bright White or Satin Anodized finish

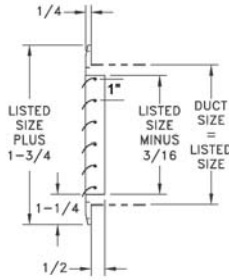

Note: Screw hole location details on page 117

		C4 Available Sizes (in.)															
		WIDTH															
HT		6	8	10	12	14	16	18	20	22	24	26	28	30	32	34	36
6	X	X	X	X	X	X	X	X	X	X	X	X	X	X	X	X	X
8		X	X	X	X	X	X	X	X	X	X	X	X	X	X	X	X
10			X	X	X	X	X	X	X	X	X	X	X	X	X	X	X
12				X	X	X	X	X	X	X	X	X	X	X	X	X	X
14					X	X	X	X	X	X	X	X	X	X	X	X	X
16						X	X	X	X	X	X	X	X	X	X	X	X
18							X	X	X	X	X	X	X	X	X	X	X
20								X	X	X	X	X	X	X	X	X	X
22									X	X	X	X	X	X	X	X	X
24										X	X	X	X	X	X	X	X
26											X	X	X	X	X	X	X
28												X	X	X	X	X	X
30													X	X	X	X	X
32														X	X	X	X
34															X	X	X
36																X	X

Other sizes available upon request



CD4 Register

- Extruded aluminum construction
- Four-way deflection
- Individually adjustable curved-face bars
- Pivoted bars for easy positive setting
- Opposed-blade damper
- Bright White or Satin Anodized finish

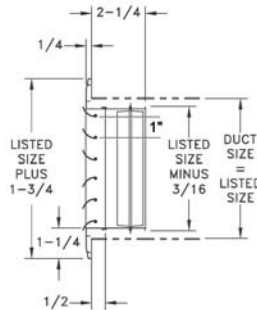

Note: Screw hole location details on page 117

		CD4 Available Sizes (in.)															
		WIDTH															
HT		6	8	10	12	14	16	18	20	22	24	26	28	30	32	34	36
6	X	X	X	X	X	X	X	X	X	X	X	X	X	X	X	X	X
8		X	X	X	X	X	X	X	X	X	X	X	X	X	X	X	X
10			X	X	X	X	X	X	X	X	X	X	X	X	X	X	X
12				X	X	X	X	X	X	X	X	X	X	X	X	X	X
14					X	X	X	X	X	X	X	X	X	X	X	X	X
16						X	X	X	X	X	X	X	X	X	X	X	X
18							X	X	X	X	X	X	X	X	X	X	X
20								X	X	X	X	X	X	X	X	X	X
22									X	X	X	X	X	X	X	X	X
24										X	X	X	X	X	X	X	X
26											X	X	X	X	X	X	X
28												X	X	X	X	X	X
30													X	X	X	X	X
32														X	X	X	X
34															X	X	X
36																X	X

Other sizes available upon request



CM4 Register

- Extruded aluminum construction
- Four-way deflection
- Individually adjustable curved-face bars
- Pivoted bars for easy positive setting
- Multi-shutter valve
- Bright White or Satin Anodized finish

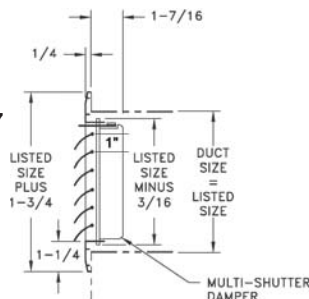

Note: Screw hole location details on page 117

		CM4 Available Sizes (in.)															
		WIDTH															
HT		6	8	10	12	14	16	18	20	22	24	26	28	30	32	34	36
6	X	X	X	X	X	X	X	X	X	X	X	X	X	X	X	X	X
8		X	X	X	X	X	X	X	X	X	X	X	X	X	X	X	X
10			X	X	X	X	X	X	X	X	X	X	X	X	X	X	X
12				X	X	X	X	X	X	X	X	X	X	X	X	X	X
14					X	X	X	X	X	X	X	X	X	X	X	X	X
16						X	X	X	X	X	X	X	X	X	X	X	X
18							X	X	X	X	X	X	X	X	X	X	X
20								X	X	X	X	X	X	X	X	X	X
22									X	X	X	X	X	X	X	X	X
24										X	X	X	X	X	X	X	X
26											X	X	X	X	X	X	X
28												X	X	X	X	X	X
30													X	X	X	X	X
32														X	X	X	X
34															X	X	X
36																X	X

Other sizes available upon request



Note: Screw hole location details on page 117

CH2CL Grille

- Extruded aluminum construction
- Two-way deflection
- Individually adjustable curved-face bars
- Pivoted bars for easy positive setting
- Bright White or Satin Anodized finish

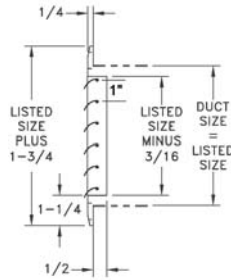

		CH2CL Available Sizes (in.)															
		WIDTH															
HT		6	8	10	12	14	16	18	20	22	24	26	28	30	32	34	36
6	X	X	X	X	X	X	X	X	X	X	X	X	X	X	X	X	X
8	X	X	X	X	X	X	X	X	X	X	X	X	X	X	X	X	X
10		X	X	X	X	X	X	X	X	X	X	X	X	X	X	X	X
12			X	X	X	X	X	X	X	X	X	X	X	X	X	X	X
14				X	X	X	X	X	X	X	X	X	X	X	X	X	X
16					X	X	X	X	X	X	X	X	X	X	X	X	X
18						X	X	X	X	X	X	X	X	X	X	X	X
20							X	X	X	X	X	X	X	X	X	X	X
22								X	X	X	X	X	X	X	X	X	X
24									X	X	X	X	X	X	X	X	X
26										X	X	X	X	X	X	X	X
28											X	X	X	X	X	X	X
30												X	X	X	X	X	X
32													X	X	X	X	X
34														X	X	X	X
36															X	X	X

Other sizes available upon request



Note: Screw hole location details on page 117

CH2CR Grille

- Extruded aluminum construction
- Two-way deflection
- Individually adjustable curved-face bars
- Pivoted bars for easy positive setting
- Bright White or Satin Anodized finish

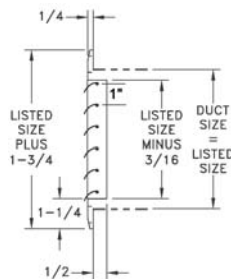

		CH2CR Available Sizes (in.)															
		WIDTH															
HT		6	8	10	12	14	16	18	20	22	24	26	28	30	32	34	36
6	X	X	X	X	X	X	X	X	X	X	X	X	X	X	X	X	X
8	X	X	X	X	X	X	X	X	X	X	X	X	X	X	X	X	X
10		X	X	X	X	X	X	X	X	X	X	X	X	X	X	X	X
12			X	X	X	X	X	X	X	X	X	X	X	X	X	X	X
14				X	X	X	X	X	X	X	X	X	X	X	X	X	X
16					X	X	X	X	X	X	X	X	X	X	X	X	X
18						X	X	X	X	X	X	X	X	X	X	X	X
20							X	X	X	X	X	X	X	X	X	X	X
22								X	X	X	X	X	X	X	X	X	X
24									X	X	X	X	X	X	X	X	X
26										X	X	X	X	X	X	X	X
28											X	X	X	X	X	X	X
30												X	X	X	X	X	X
32													X	X	X	X	X
34														X	X	X	X
36															X	X	X

Other sizes available upon request



Blades at 40° angle

RCB Grille RCBD Register

- Extruded aluminum construction
- Curved blades fixed on one-inch spacing
- Opposed-blade damper
- Bright White or Satin Anodized finish

		RCB, RCBD Available Sizes (in.)																					
		WIDTH																					
HT	6	8	10	12	14	16	18	20	22	24	26	28	30	32	34	36	38	40	42	44	46	48	
	4	X	X	X	X	X	X	X	X	X	X	X	X	X	X	X	X	X	X	X	X	X	X
5	X	X	X	X	X	X	X	X	X	X	X	X	X	X	X	X	X	X	X	X	X	X	X
6	X	X	X	X	X	X	X	X	X	X	X	X	X	X	X	X	X	X	X	X	X	X	X
8	X	X	X	X	X	X	X	X	X	X	X	X	X	X	X	X	X	X	X	X	X	X	X
10			X	X	X	X	X	X	X	X	X	X	X	X	X	X	X	X	X	X	X	X	X
12				X	X	X	X	X	X	X	X	X	X	X	X	X	X	X	X	X	X	X	X
14					X	X	X	X	X	X	X	X	X	X	X	X	X	X	X	X	X	X	X
16						X	X	X	X	X	X	X	X	X	X	X	X	X	X	X	X	X	X
18							X	X	X	X	X	X	X	X	X	X	X	X	X	X	X	X	X
20								X	X	X	X	X	X	X	X	X	X	X	X	X	X	X	X
22									X	X	X	X	X	X	X	X	X	X	X	X	X	X	X
24										X	X	X	X	X	X	X	X	X	X	X	X	X	X
26											X	X	X	X	X	X	X	X	X	X	X	X	X
28												X	X	X	X	X	X	X	X	X	X	X	X
30													X	X	X	X	X	X	X	X	X	X	X
32														X	X	X	X	X	X	X	X	X	X
34															X	X	X	X	X	X	X	X	X
36																X	X	X	X	X	X	X	X
38																	X	X	X	X	X	X	X
40																		X	X	X	X	X	X
42																			X	X	X	X	X
44																				X	X	X	X
46																					X	X	X
48																						X	X

Other sizes available upon request

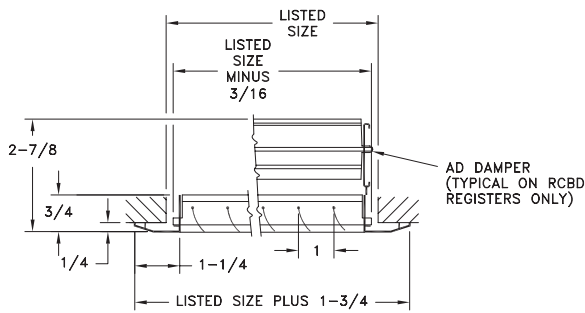

Blades at 40° angle

RCBF Filter Grille

- Extruded aluminum construction
- Horizontal curved blades
- Utilizes RCB grille
- Hinged on bottom edge
- Accommodates standard 1" thick disposable filter (not included)
- Filter grilles equipped with spring fasteners
- Filters not furnished
- Bright White or Satin Anodized finish

		RCBF Available Sizes (in.)																					
		WIDTH																					
HT	6	8	10	12	14	16	18	20	22	24	25	26	28	30	32	34	36	38	40	42	44	46	48
	6	X	X	X	X	X	X	X	X	X	X		X	X	X	X	X	X	X	X	X	X	X
8		X	X	X	X	X	X	X	X	X		X	X	X	X	X	X	X	X	X	X	X	X
10			X	X	X	X	X	X	X	X		X	X	X	X	X	X	X	X	X	X	X	X
12				X	X	X	X	X	X	X		X	X	X	X	X	X	X	X	X	X	X	X
14					X	X	X	X	X	X		X	X	X	X	X	X	X	X	X	X	X	X
16						X	X	X	X	X		X	X	X	X	X	X	X	X	X	X	X	X
18							X	X	X	X		X	X	X	X	X	X	X	X	X	X	X	X
20								X	X	X		X	X	X	X	X	X	X	X	X	X	X	X
22									X	X		X	X	X	X	X	X	X	X	X	X	X	X
24										X		X	X	X	X	X	X	X	X	X	X	X	X
25											X												
26												X	X	X	X	X	X	X	X	X	X	X	X
28													X	X	X	X	X	X	X	X	X	X	X
30														X	X	X	X	X	X	X	X	X	X
32															X	X	X	X	X	X	X	X	X
34																X	X	X	X	X	X	X	X
36																	X	X	X	X	X	X	X
38																		X	X	X	X	X	X
40																			X	X	X	X	X
42																				X	X	X	X
44																					X	X	X
46																						X	X
48																							X

Other sizes available upon request

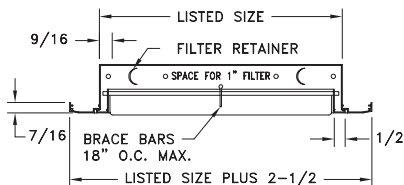

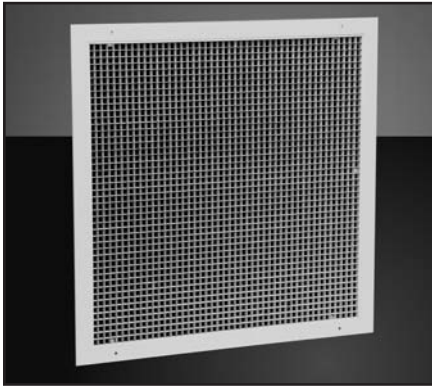

RE5 Grille

- All-aluminum construction
- Grid core 1/2" x 1/2" x 1/2"
- Square core design with extruded aluminum frame
- Bright White or Mill finish

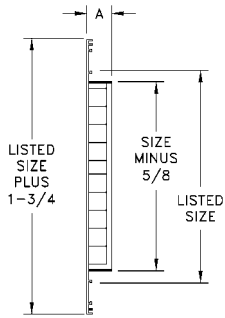

MODEL	GRID CORE DIMENSIONS	A
RE5	1/2 x 1/2 x 1/2	1-1/16
RE510	1/2 x 1/2 x 1	1-9/16
RE1	1 x 1 x 1	1-9/16

		RE5 Available Sizes (in.)																				
		WIDTH																				
HT	WIDTH																					
	6	8	10	12	14	16	18	20	22	24	26	28	30	32	34	36	38	40	42	44	46	48
4	X	X	X	X	X	X	X	X	X	X	X	X	X	X	X	X	X	X	X	X	X	X
5	X	X	X	X	X	X	X	X	X	X	X	X	X	X	X	X	X	X	X	X	X	X
6	X	X	X	X	X	X	X	X	X	X	X	X	X	X	X	X	X	X	X	X	X	X
8		X	X	X	X	X	X	X	X	X	X	X	X	X	X	X	X	X	X	X	X	X
10			X	X	X	X	X	X	X	X	X	X	X	X	X	X	X	X	X	X	X	X
12				X	X	X	X	X	X	X	X	X	X	X	X	X	X	X	X	X	X	X
14					X	X	X	X	X	X	X	X	X	X	X	X	X	X	X	X	X	X
16						X	X	X	X	X	X	X	X	X	X	X	X	X	X	X	X	X
18							X	X	X	X	X	X	X	X	X	X	X	X	X	X	X	X
20								X	X	X	X	X	X	X	X	X	X	X	X	X	X	X
22									X	X	X	X	X	X	X	X	X	X	X	X	X	X
24										X	X	X	X	X	X	X	X	X	X	X	X	X
26											X	X	X	X	X	X	X	X	X	X	X	X
28												X	X	X	X	X	X	X	X	X	X	X
30													X	X	X	X	X	X	X	X	X	X
32														X	X	X	X	X	X	X	X	X
34															X	X	X	X	X	X	X	X
36																X	X	X	X	X	X	X
38																	X	X	X	X	X	X
40																		X	X	X	X	X
42																			X	X	X	X
44																				X	X	X
46																					X	X
48																						X

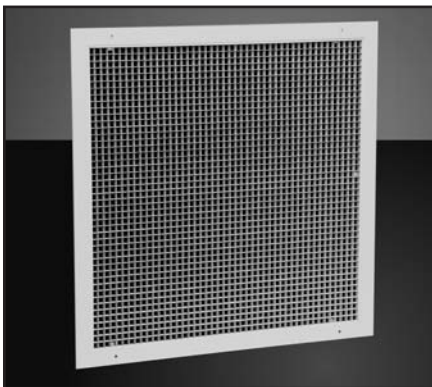

RED5 Register

- All-aluminum construction
- Opposed-blade damper galvanized
- Square core design with extruded aluminum construction
- Bright White or Mill finish

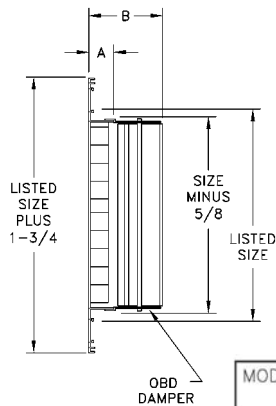

MODEL	GRID CORE DIMENSIONS	A	B
RE5	1/2 x 1/2 x 1/2	1-1/16	2-3/8
RE510	1/2 x 1/2 x 1	1-9/16	2-7/8
RE1	1 x 1 x 1	1-9/16	2-7/8

		RED5 Available Sizes (in.)																				
		WIDTH																				
HT	WIDTH																					
	6	8	10	12	14	16	18	20	22	24	26	28	30	32	34	36	38	40	42	44	46	48
4	X	X	X	X	X	X	X	X	X	X	X	X	X	X	X	X	X	X	X	X	X	X
5	X	X	X	X	X	X	X	X	X	X	X	X	X	X	X	X	X	X	X	X	X	X
6	X	X	X	X	X	X	X	X	X	X	X	X	X	X	X	X	X	X	X	X	X	X
8	X	X	X	X	X	X	X	X	X	X	X	X	X	X	X	X	X	X	X	X	X	X
10	X	X	X	X	X	X	X	X	X	X	X	X	X	X	X	X	X	X	X	X	X	X
12			X	X	X	X	X	X	X	X	X	X	X	X	X	X	X	X	X	X	X	X
14				X	X	X	X	X	X	X	X	X	X	X	X	X	X	X	X	X	X	X
16					X	X	X	X	X	X	X	X	X	X	X	X	X	X	X	X	X	X
18						X	X	X	X	X	X	X	X	X	X	X	X	X	X	X	X	X
20							X	X	X	X	X	X	X	X	X	X	X	X	X	X	X	X
22								X	X	X	X	X	X	X	X	X	X	X	X	X	X	X
24									X	X	X	X	X	X	X	X	X	X	X	X	X	X
26										X	X	X	X	X	X	X	X	X	X	X	X	X
28											X	X	X	X	X	X	X	X	X	X	X	X
30												X	X	X	X	X	X	X	X	X	X	X
32													X	X	X	X	X	X	X	X	X	X
34														X	X	X	X	X	X	X	X	X
36															X	X	X	X	X	X	X	X
38																X	X	X	X	X	X	X
40																	X	X	X	X	X	X
42																		X	X	X	X	X
44																			X	X	X	X
46																				X	X	X
48																					X	X

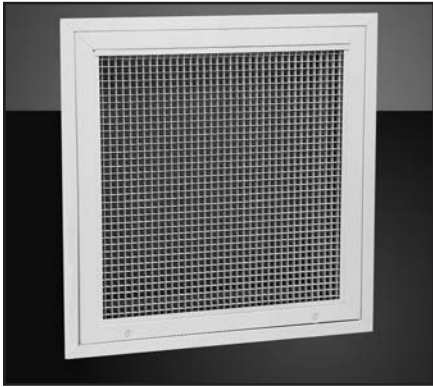

REF5 Filter Grille, Grid Core

- All-aluminum construction
- 1/2" x 1/2" x 1/2" square core design
- Accommodates standard 1" thick disposable filter (not included)
- Filter grilles equipped with knurled knob fasteners
- Bright White or Mill finish

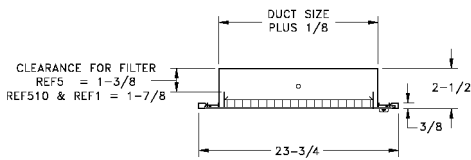

REF5 Available Sizes (in.)		WIDTH																	
		6	8	10	12	14	16	18	20	22	24	25	26	28	30	32	34	36	
HT	4	X	X	X	X	X	X	X	X	X	X	X	X	X	X	X	X	X	
5	X	X	X	X	X	X	X	X	X	X	X	X	X	X	X	X	X	X	
6	X	X	X	X	X	X	X	X	X	X	X	X	X	X	X	X	X	X	
8	X	X	X	X	X	X	X	X	X	X	X	X	X	X	X	X	X	X	
10			X	X	X	X	X	X	X	X	X	X	X	X	X	X	X	X	
12				X	X	X	X	X	X	X	X	X	X	X	X	X	X	X	
14					X	X	X	X	X	X	X	X	X	X	X	X	X	X	
16						X	X	X	X	X	X	X	X	X	X	X	X	X	
18							X	X	X	X	X	X	X	X	X	X	X	X	
20								X	X	X	X	X	X	X	X	X	X	X	
22									X	X	X	X	X	X	X	X	X	X	
24										X	X	X	X	X	X	X	X	X	
25										X		X							
26												X	X	X	X	X	X	X	
28													X	X	X	X	X	X	
30														X	X	X	X	X	
32															X	X	X	X	
34																X	X	X	
36																	X	X	



RH45 Grille

- Extruded aluminum construction
- Horizontal bars at 45 degrees
- Face bars permanently fixed into heavy aluminum frames at a 45-degree angle
- Bright White or Satin Anodized finish

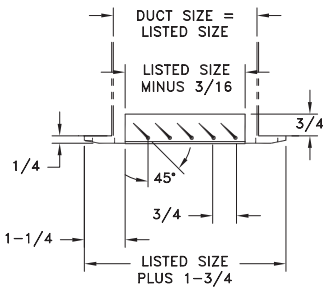

RH45 Available Sizes (in.)		WIDTH																						
		4	6	8	10	12	14	16	18	20	22	24	26	28	30	32	34	36	38	40	42	44	46	48
HT	4	X	X	X	X	X	X	X	X	X	X	X	X	X	X	X	X	X	X	X	X	X	X	X
5	X	X	X	X	X	X	X	X	X	X	X	X	X	X	X	X	X	X	X	X	X	X	X	X
6	X	X	X	X	X	X	X	X	X	X	X	X	X	X	X	X	X	X	X	X	X	X	X	X
8	X	X	X	X	X	X	X	X	X	X	X	X	X	X	X	X	X	X	X	X	X	X	X	X
10				X	X	X	X	X	X	X	X	X	X	X	X	X	X	X	X	X	X	X	X	X
12					X	X	X	X	X	X	X	X	X	X	X	X	X	X	X	X	X	X	X	X
14						X	X	X	X	X	X	X	X	X	X	X	X	X	X	X	X	X	X	X
16							X	X	X	X	X	X	X	X	X	X	X	X	X	X	X	X	X	X
18								X	X	X	X	X	X	X	X	X	X	X	X	X	X	X	X	X
20									X	X	X	X	X	X	X	X	X	X	X	X	X	X	X	X
22										X	X	X	X	X	X	X	X	X	X	X	X	X	X	X
24											X	X	X	X	X	X	X	X	X	X	X	X	X	X
26												X	X	X	X	X	X	X	X	X	X	X	X	X
28													X	X	X	X	X	X	X	X	X	X	X	X
30														X	X	X	X	X	X	X	X	X	X	X
32															X	X	X	X	X	X	X	X	X	X
34																X	X	X	X	X	X	X	X	X
36																	X	X	X	X	X	X	X	X
38																		X	X	X	X	X	X	X
40																			X	X	X	X	X	X
42																				X	X	X	X	X
44																					X	X	X	X
46																						X	X	X
48																							X	X

Other sizes available upon request



RHD45 Register

- Extruded aluminum construction
- Horizontal bars at 45 degrees
- Face bars permanently fixed into heavy aluminum frames at a 45-degree angle
- Opposed-blade damper
- Bright White or Satin Anodized finish

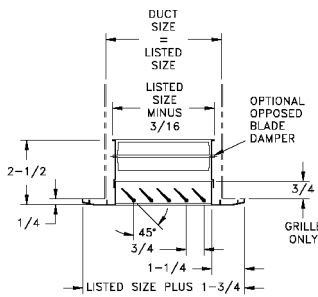

RHD45 Available Sizes (in.)		WIDTH																					
		6	8	10	12	14	16	18	20	22	24	26	28	30	32	34	36	38	40	42	44	46	48
HT	4	X	X	X	X	X	X	X	X	X	X	X	X	X	X	X	X	X	X	X	X	X	X
5	X	X	X	X	X	X	X	X	X	X	X	X	X	X	X	X	X	X	X	X	X	X	X
6	X	X	X	X	X	X	X	X	X	X	X	X	X	X	X	X	X	X	X	X	X	X	X
8		X	X	X	X	X	X	X	X	X	X	X	X	X	X	X	X	X	X	X	X	X	X
10			X	X	X	X	X	X	X	X	X	X	X	X	X	X	X	X	X	X	X	X	X
12				X	X	X	X	X	X	X	X	X	X	X	X	X	X	X	X	X	X	X	X
14					X	X	X	X	X	X	X	X	X	X	X	X	X	X	X	X	X	X	X
16						X	X	X	X	X	X	X	X	X	X	X	X	X	X	X	X	X	X
18							X	X	X	X	X	X	X	X	X	X	X	X	X	X	X	X	X
20								X	X	X	X	X	X	X	X	X	X	X	X	X	X	X	X
22									X	X	X	X	X	X	X	X	X	X	X	X	X	X	X
24										X	X	X	X	X	X	X	X	X	X	X	X	X	X
26											X	X	X	X	X	X	X	X	X	X	X	X	X
28												X	X	X	X	X	X	X	X	X	X	X	X
30													X	X	X	X	X	X	X	X	X	X	X
32														X	X	X	X	X	X	X	X	X	X
34															X	X	X	X	X	X	X	X	X
36																X	X	X	X	X	X	X	X
38																	X	X	X	X	X	X	X
40																		X	X	X	X	X	X
42																			X	X	X	X	X
44																				X	X	X	X
46																					X	X	X
48																						X	X

Other sizes available upon request



RHF45 Filter Grille

- Extruded aluminum construction
- Horizontal bars at 45 degrees
- Hinged on the bottom edge
- Accommodates standard 1" thick disposable filter (not included)
- RHF45 utilizes the RH45 extruded aluminum grille
- Filter grilles equipped with spring fasteners
- Bright White or Satin Anodized finish

Note: CFM capacity is equal to the filter capacity rating of two CFM per square inch of gross filter area.

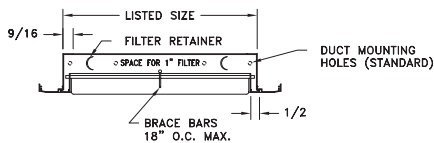

RHF45 END VIEW

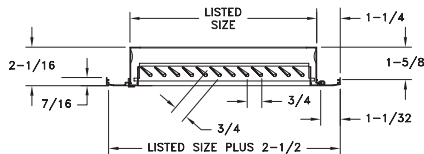

RHF45 SIDE VIEW

RHF45 Available Sizes (in.)		WIDTH																					
		6	8	10	12	14	16	18	20	22	24	25	26	28	30	32	34	36	38	40	42	44	46
HT	6	X	X	X	X	X	X	X	X	X		X	X	X	X	X	X	X	X	X	X	X	X
8		X	X	X	X	X	X	X	X			X	X	X	X	X	X	X	X	X	X	X	X
10			X	X	X	X	X	X	X				X	X	X	X	X	X	X	X	X	X	X
12				X	X	X	X	X	X					X	X	X	X	X	X	X	X	X	X
14					X	X	X	X	X						X	X	X	X	X	X	X	X	X
16						X	X	X	X							X	X	X	X	X	X	X	X
18							X	X	X								X	X	X	X	X	X	X
20								X	X									X	X	X	X	X	X
22									X										X	X	X	X	X
24										X										X	X	X	X
25											X												
26												X											
28													X										
30														X									
32															X								
34																X							
36																	X						
38																		X					
40																			X				
42																				X			
44																					X		
46																						X	
48																							X

Other sizes available upon request



RH90 Grille

- Extruded aluminum construction
- Face bars permanently fixed into heavy aluminum frames at a 90-degree angle from face
- Bright White or Satin Anodized finish

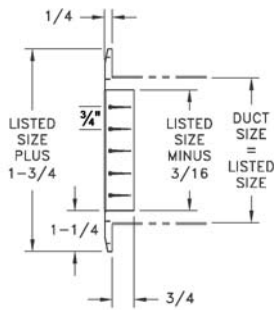

		RH90 Available Sizes (in.)																					
		WIDTH																					
HT	4	6	8	10	12	14	16	18	20	22	24	26	28	30	32	34	36	38	40	42	44	46	48
	4	X	X	X	X	X	X	X	X	X	X	X	X	X	X	X	X	X	X	X	X	X	X
5	X	X	X	X	X	X	X	X	X	X	X	X	X	X	X	X	X	X	X	X	X	X	X
6	X	X	X	X	X	X	X	X	X	X	X	X	X	X	X	X	X	X	X	X	X	X	X
8	X	X	X	X	X	X	X	X	X	X	X	X	X	X	X	X	X	X	X	X	X	X	X
10				X	X	X	X	X	X	X	X	X	X	X	X	X	X	X	X	X	X	X	X
12					X	X	X	X	X	X	X	X	X	X	X	X	X	X	X	X	X	X	X
14						X	X	X	X	X	X	X	X	X	X	X	X	X	X	X	X	X	X
16							X	X	X	X	X	X	X	X	X	X	X	X	X	X	X	X	X
18								X	X	X	X	X	X	X	X	X	X	X	X	X	X	X	X
20									X	X	X	X	X	X	X	X	X	X	X	X	X	X	X
22										X	X	X	X	X	X	X	X	X	X	X	X	X	X
24											X	X	X	X	X	X	X	X	X	X	X	X	X
26												X	X	X	X	X	X	X	X	X	X	X	X
28													X	X	X	X	X	X	X	X	X	X	X
30														X	X	X	X	X	X	X	X	X	X
32															X	X	X	X	X	X	X	X	X
34																X	X	X	X	X	X	X	X
36																	X	X	X	X	X	X	X
38																		X	X	X	X	X	X
40																			X	X	X	X	X
42																				X	X	X	X
44																					X	X	X
46																						X	X
48																							X

Other sizes available upon request



RHD90 Register

- Extruded aluminum construction
- Face bars permanently fixed into heavy aluminum frames at a 90-degree angle from face
- Opposed-blade damper
- Bright White or Satin Anodized finish

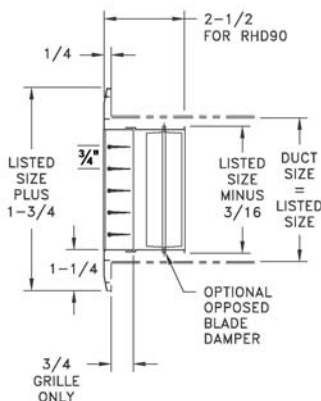

		RHD90 Available Sizes (in.)																				
		WIDTH																				
HT	6	8	10	12	14	16	18	20	22	24	26	28	30	32	34	36	38	40	42	44	46	48
	4	X	X	X	X	X	X	X	X	X	X	X	X	X	X	X	X	X	X	X	X	X
5	X	X	X	X	X	X	X	X	X	X	X	X	X	X	X	X	X	X	X	X	X	X
6	X	X	X	X	X	X	X	X	X	X	X	X	X	X	X	X	X	X	X	X	X	X
8	X	X	X	X	X	X	X	X	X	X	X	X	X	X	X	X	X	X	X	X	X	X
10			X	X	X	X	X	X	X	X	X	X	X	X	X	X	X	X	X	X	X	X
12				X	X	X	X	X	X	X	X	X	X	X	X	X	X	X	X	X	X	X
14					X	X	X	X	X	X	X	X	X	X	X	X	X	X	X	X	X	X
16						X	X	X	X	X	X	X	X	X	X	X	X	X	X	X	X	X
18							X	X	X	X	X	X	X	X	X	X	X	X	X	X	X	X
20								X	X	X	X	X	X	X	X	X	X	X	X	X	X	X
22									X	X	X	X	X	X	X	X	X	X	X	X	X	X
24										X	X	X	X	X	X	X	X	X	X	X	X	X
26											X	X	X	X	X	X	X	X	X	X	X	X
28												X	X	X	X	X	X	X	X	X	X	X
30													X	X	X	X	X	X	X	X	X	X
32														X	X	X	X	X	X	X	X	X
34															X	X	X	X	X	X	X	X
36																X	X	X	X	X	X	X
38																	X	X	X	X	X	X
40																		X	X	X	X	X
42																			X	X	X	X
44																				X	X	X
46																					X	X
48																						X



TG Transfer Grille

- Extruded aluminum construction
- Vision proof
- Inverted "Y" type grille bar for best vision proof quality and airflow
- Excellent for installation in doors or partitions
- Bright White or Satin Anodized finish



TGF Transfer Grille Frame

- Extruded aluminum construction

Note: When framing both sides of the door or partition opening, use the TGF frame with the TG Grille. Adjustable from 1" to 2 1/8" door thickness.

TG/TGF Transfer Grille with Transfer Grille Frame

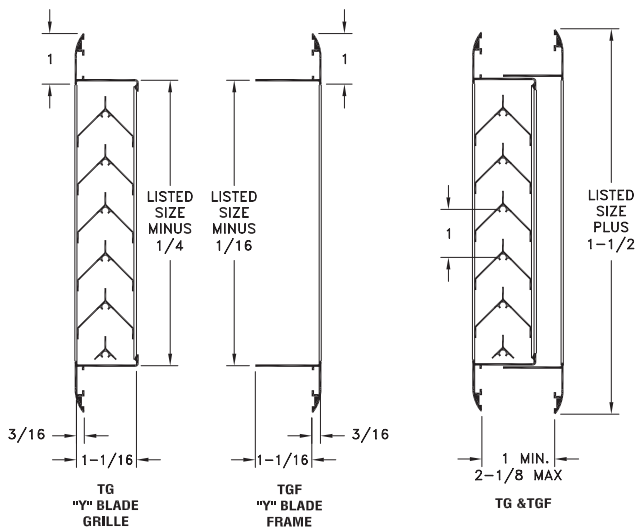

		TG/TGF Available Sizes (in.)															
		WIDTH															
HT	6	8	10	12	14	16	18	20	22	24	26	28	30	32	34	36	
	6	X	X	X	X	X	X	X	X	X	X	X	X	X	X	X	X
8		X	X	X	X	X	X	X	X	X	X	X	X	X	X	X	
10			X	X	X	X	X	X	X	X	X	X	X	X	X	X	
12				X	X	X	X	X	X	X	X	X	X	X	X	X	
14					X	X	X	X	X	X	X	X	X	X	X	X	
16						X	X	X	X	X	X	X	X	X	X	X	
18							X	X	X	X	X	X	X	X	X	X	
20								X	X	X	X	X	X	X	X	X	
22									X	X	X	X	X	X	X	X	
24										X	X	X	X	X	X	X	
26											X	X	X	X	X	X	
28												X	X	X	X	X	
30													X	X	X	X	
32														X	X	X	
34															X	X	
36																X	

Other sizes available upon request